

DEALER			COLOURS INFORMATION For Office Use Only		
Dealer:			Order Date:		S/N:
Account:		P.O.#:	RTS		
Ordered By:			RTS:		Phone:
Address:			Email:		
City:		State:	Zip:		SHIP TO
Phone:		Fax:	Name:		Ship Via:
Email:			Address:		
Customer Name:			City:		State: Zip:
Customer Weight:			Phone:		Fax:

CHAIR INFORMATION	PRICE
CHUMP-G E1235	Base Wheel Chair Price E1235 \$ 1,550
Adjustable FSH-RSH	Total Section A \$
Max. Capacity 250Lbs	Total Section B \$
NOTE	Total Section C \$
Chump-G is the economical solution when you want to grow your Chair by changing the seat depth and width after ordering.	Total Section D \$
Main Frame : ZK55 & ZK60 High Grade A7000 Series Aluminum	Total Section E \$
Main Frame : Lifetime Warranty *See warranty Policy	Total Section F \$
	ORDER GRAND TOTAL \$

A FRAME COLORS & PARTS COLORS

FRAME COLORS							
Powder-Co	<input type="checkbox"/> Gloss Black	<input type="checkbox"/> Twilight Flake	<input type="checkbox"/> Yellow	<input type="checkbox"/> Magenta	<input type="checkbox"/> Fire Engine Red	<input type="checkbox"/> White	\$ STD
	<input type="checkbox"/> Candy Blue	<input type="checkbox"/> Candy Purple	<input type="checkbox"/> Candy Green	<input type="checkbox"/> Candy Red	<input type="checkbox"/> Candy Raspberry	<input type="checkbox"/> Cobalt Blue	
	<input type="checkbox"/> Matte Gray	<input type="checkbox"/> Matte Purple	<input type="checkbox"/> Matte Blue	<input type="checkbox"/> Matte Green	<input type="checkbox"/> Matte Black	<input type="checkbox"/> Matte Red	
	<input type="checkbox"/> Neon Red	<input type="checkbox"/> Neon Green	<input type="checkbox"/> Orange Sparkle	<input type="checkbox"/> Mellon Yellow	<input type="checkbox"/> Gun Smoke Silver	<input type="checkbox"/> Pigeon Blue	
	<input type="checkbox"/> Granny Sparkle Green	<input type="checkbox"/> Sparkle Sky Blue	<input type="checkbox"/> Vermilion	<input type="checkbox"/> Reed Green	<input type="checkbox"/> Blue Lilac		\$ STD
Special	<input type="checkbox"/> Polished						\$ 800
	<input type="checkbox"/> 24 karat Gold Plated						\$ CFP

PARTS COLORS		
STD Color	Black Color (*Suspension Springs-Silver Color)	\$ STD
Custom Color Main Bolt on Parts One Color Package	<input type="checkbox"/> Powder-Coated ()	\$ 500
	<input type="checkbox"/> Polished	\$ 750
	<input type="checkbox"/> 24 karat Gold Plated	\$ CFP
Including: Backrest, Foot Plate, Footrest Rings, Backrest Brackets, Saddle Stops, Forks & Knurl Nuts, Caps, Front Suspension Springs, Axle Tube, Axle Clamps, Axle Plates, Axle Bases, Camber Discs, Caster Housings ☆marked parts		

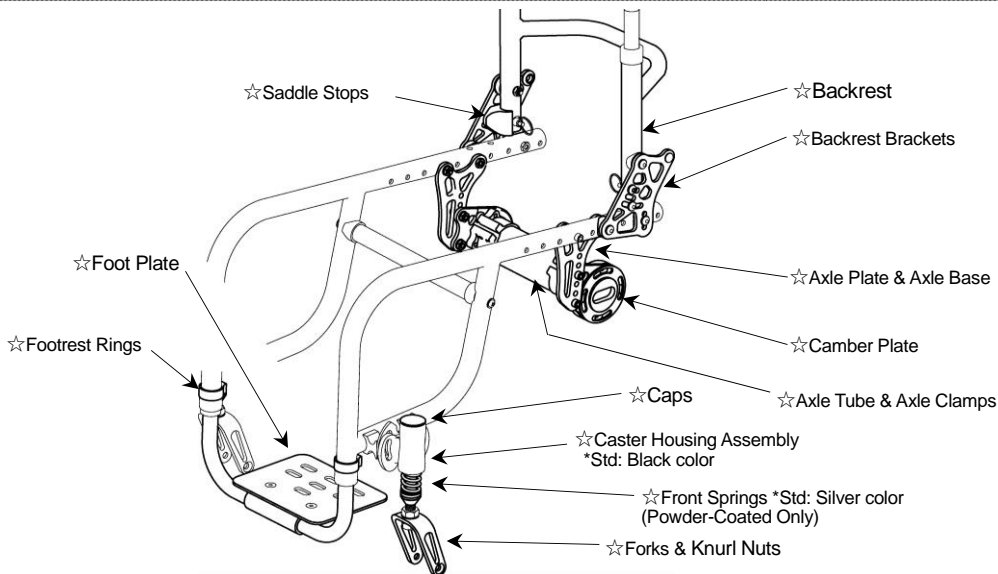

Total Section A \$

B FRAME MEASUREMENTS 1/2

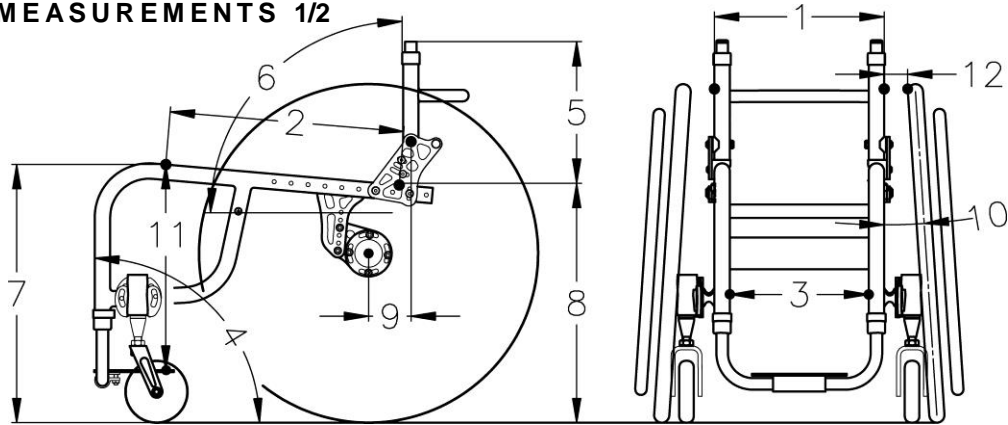

1. SEAT WIDTH	<input type="checkbox"/> 10" <input type="checkbox"/> 11" <input type="checkbox"/> 12" <input type="checkbox"/> 13" <input type="checkbox"/> 14" 	\$ STD
----------------------	--	----------

2. SEAT DEPTH	Depth Adj. Frame	<input type="checkbox"/> Short Frame (12" Depth) Set at <input type="checkbox"/> 10" <input type="checkbox"/> 11" <input type="checkbox"/> 12" 	\$ STD
		<input type="checkbox"/> STD. Frame (15" Depth) Set at <input type="checkbox"/> 12" <input type="checkbox"/> 13" <input type="checkbox"/> 14" <input type="checkbox"/> 15" 	\$ STD

3. FOOTREST WIDTH	<input type="checkbox"/> STD (Seat Width Minus 2", No Taper Frame) 	\$ STD
--------------------------	---	----------

*No Custom Modifications

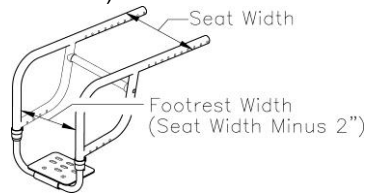

FOOT PLATE STYLE	<input type="checkbox"/> Standard single loop with adjust. height & angle. STD Foot Plate 	\$ STD
	<input type="checkbox"/> Single Flip-Back-single loop (no riser avail) with adjust. height & angle. STD Foot Plate 	K0040 \$ 150

STD Foot Plate Size Chart

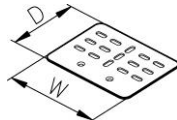

Your Seat Width	Foot Plate Size
10"-12"	W6.5"xD5"
13"-14"	W8.5"xD6.5"

*No Custom Modifications

4. FRAME BEND ANGLE	<input type="checkbox"/> 95° only 	\$ STD
----------------------------	---	----------

*No Custom Modifications

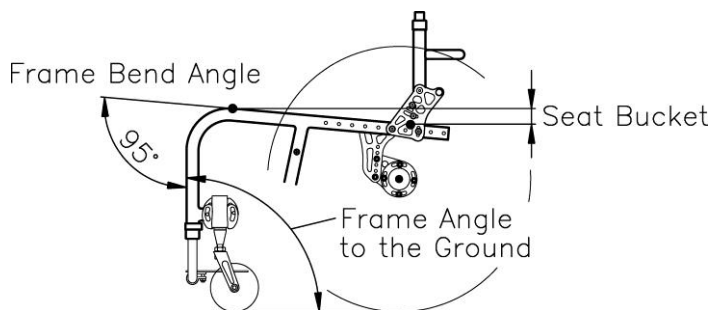

FRAME ANGLE to the Ground

		Your Seat Depth					
		10"	11"	12"	13"	14"	15"
Seat Bucket	0"	95°	95°	95°	95°	95°	95°
	1"	89°	90°	90°	91°	91°	91°
	2"	83°	85°	85°	86°	87°	87°
	3"	78°	79°	81°	82°	83°	83°
	4"	71°	74°	76°	77°	78°	80°
	5"	65°	68°	70°	72°	74°	76°

B FRAME MEASUREMENTS 2/2

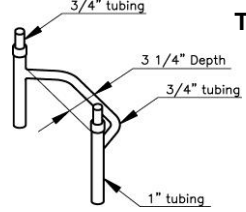
5. BACKREST HEIGHT	<input type="checkbox"/> 8" <input type="checkbox"/> 9" <input type="checkbox"/> 10" <input type="checkbox"/> 11" <input type="checkbox"/> 12" <input type="checkbox"/> 13" <input type="checkbox"/> 14" <input type="checkbox"/> 15" <input type="checkbox"/> 16" <input type="checkbox"/> 17" <input type="checkbox"/> 18"	\$ STD																																																																																																														
* Rigidizer bar 3.25" deep std.																																																																																																																
	Type <input type="checkbox"/> Locking mechan. with adjust. height & angle	\$ STD																																																																																																														
	<input type="checkbox"/> Double Locking mechan. with adjust. height & angle	\$ 25																																																																																																														
	<input type="checkbox"/> Folding with adjust. height & angle	\$ NCO																																																																																																														
	*No Custom Modifications																																																																																																															
6. BACKREST ANGLE	Set at (°) to the ground *STD 90°	\$ STD																																																																																																														
7. FRONT SEAT HEIGHT	<input type="checkbox"/> 14.5" <input type="checkbox"/> 15.0" <input type="checkbox"/> 15.5" <input type="checkbox"/> 16.0" <input type="checkbox"/> 16.5" <input type="checkbox"/> 17.0" <input type="checkbox"/> 17.5" <input type="checkbox"/> 18.0" <input type="checkbox"/> 18.5"	\$ STD																																																																																																														
The front seat heights are impacted by the size of your front caster.																																																																																																																
STD Front Seat Height Rang *=Not Available with Quick Release Caster Axle. *No Custom Modifications	<table border="1" style="width:100%; border-collapse: collapse;"> <thead> <tr> <th colspan="2" rowspan="2"></th> <th colspan="8">Front Seat Height</th> </tr> <tr> <th>14.5"</th> <th>15.0"</th> <th>15.5"</th> <th>16.0"</th> <th>16.5"</th> <th>17.0"</th> <th>17.5"</th> <th>18.0"</th> <th>18.5"</th> </tr> </thead> <tbody> <tr> <td rowspan="8" style="writing-mode: vertical-rl; transform: rotate(180deg);">Your Casters & Forks</td> <td>3"Caster & STD Forks</td> <td><input type="checkbox"/>*</td> <td><input type="checkbox"/>*</td> <td><input type="checkbox"/></td> <td><input type="checkbox"/></td> <td><input type="checkbox"/></td> <td><input type="checkbox"/></td> <td><input type="checkbox"/></td> <td></td> <td></td> </tr> <tr> <td>3"Caster & Springs</td> <td></td> <td><input type="checkbox"/></td> <td><input type="checkbox"/></td> <td><input type="checkbox"/></td> <td><input type="checkbox"/></td> <td><input type="checkbox"/></td> <td></td> <td></td> <td></td> </tr> <tr> <td>3"Caster & Frog Legs</td> <td></td> <td></td> <td><input type="checkbox"/>*</td> <td><input type="checkbox"/>*</td> <td><input type="checkbox"/>*</td> <td><input type="checkbox"/>*</td> <td><input type="checkbox"/>*</td> <td><input type="checkbox"/>*</td> <td></td> </tr> <tr> <td>4"Caster & STD Forks</td> <td></td> <td><input type="checkbox"/></td> <td><input type="checkbox"/></td> <td><input type="checkbox"/></td> <td><input type="checkbox"/></td> <td><input type="checkbox"/></td> <td><input type="checkbox"/></td> <td><input type="checkbox"/></td> <td></td> </tr> <tr> <td>4"Caster & Springs</td> <td></td> <td></td> <td><input type="checkbox"/></td> <td><input type="checkbox"/></td> <td><input type="checkbox"/></td> <td><input type="checkbox"/></td> <td><input type="checkbox"/></td> <td><input type="checkbox"/></td> <td></td> </tr> <tr> <td>4"Caster & Frog Legs</td> <td></td> <td></td> <td><input type="checkbox"/>*</td> <td><input type="checkbox"/>*</td> <td><input type="checkbox"/>*</td> <td><input type="checkbox"/>*</td> <td><input type="checkbox"/>*</td> <td><input type="checkbox"/>*</td> <td><input type="checkbox"/>*</td> </tr> <tr> <td>5"Caster & STD Forks</td> <td></td> <td></td> <td></td> <td><input type="checkbox"/>*</td> <td><input type="checkbox"/></td> <td><input type="checkbox"/></td> <td><input type="checkbox"/></td> <td><input type="checkbox"/></td> <td><input type="checkbox"/>*</td> </tr> <tr> <td>5"Caster & Springs</td> <td></td> <td></td> <td></td> <td><input type="checkbox"/>*</td> <td><input type="checkbox"/>*</td> <td><input type="checkbox"/>*</td> <td><input type="checkbox"/>*</td> <td><input type="checkbox"/>*</td> <td><input type="checkbox"/>*</td> </tr> <tr> <td>5"Caster & Frog Legs</td> <td></td> <td></td> <td></td> <td></td> <td><input type="checkbox"/>*</td> <td><input type="checkbox"/>*</td> <td><input type="checkbox"/>*</td> <td><input type="checkbox"/>*</td> <td><input type="checkbox"/>*</td> </tr> </tbody> </table>			Front Seat Height								14.5"	15.0"	15.5"	16.0"	16.5"	17.0"	17.5"	18.0"	18.5"	Your Casters & Forks	3"Caster & STD Forks	<input type="checkbox"/> *	<input type="checkbox"/> *	<input type="checkbox"/>	<input type="checkbox"/>	<input type="checkbox"/>	<input type="checkbox"/>	<input type="checkbox"/>			3"Caster & Springs		<input type="checkbox"/>	<input type="checkbox"/>	<input type="checkbox"/>	<input type="checkbox"/>	<input type="checkbox"/>				3"Caster & Frog Legs			<input type="checkbox"/> *	<input type="checkbox"/> *	<input type="checkbox"/> *	<input type="checkbox"/> *	<input type="checkbox"/> *	<input type="checkbox"/> *		4"Caster & STD Forks		<input type="checkbox"/>	<input type="checkbox"/>	<input type="checkbox"/>	<input type="checkbox"/>	<input type="checkbox"/>	<input type="checkbox"/>	<input type="checkbox"/>		4"Caster & Springs			<input type="checkbox"/>	<input type="checkbox"/>	<input type="checkbox"/>	<input type="checkbox"/>	<input type="checkbox"/>	<input type="checkbox"/>		4"Caster & Frog Legs			<input type="checkbox"/> *	<input type="checkbox"/> *	<input type="checkbox"/> *	<input type="checkbox"/> *	<input type="checkbox"/> *	<input type="checkbox"/> *	<input type="checkbox"/> *	5"Caster & STD Forks				<input type="checkbox"/> *	<input type="checkbox"/>	<input type="checkbox"/>	<input type="checkbox"/>	<input type="checkbox"/>	<input type="checkbox"/> *	5"Caster & Springs				<input type="checkbox"/> *	<input type="checkbox"/> *	<input type="checkbox"/> *	<input type="checkbox"/> *	<input type="checkbox"/> *	<input type="checkbox"/> *	5"Caster & Frog Legs					<input type="checkbox"/> *	<input type="checkbox"/> *	<input type="checkbox"/> *	<input type="checkbox"/> *	<input type="checkbox"/> *	
				Front Seat Height																																																																																																												
		14.5"	15.0"	15.5"	16.0"	16.5"	17.0"	17.5"	18.0"	18.5"																																																																																																						
Your Casters & Forks	3"Caster & STD Forks	<input type="checkbox"/> *	<input type="checkbox"/> *	<input type="checkbox"/>	<input type="checkbox"/>	<input type="checkbox"/>	<input type="checkbox"/>	<input type="checkbox"/>																																																																																																								
	3"Caster & Springs		<input type="checkbox"/>	<input type="checkbox"/>	<input type="checkbox"/>	<input type="checkbox"/>	<input type="checkbox"/>																																																																																																									
	3"Caster & Frog Legs			<input type="checkbox"/> *	<input type="checkbox"/> *	<input type="checkbox"/> *	<input type="checkbox"/> *	<input type="checkbox"/> *	<input type="checkbox"/> *																																																																																																							
	4"Caster & STD Forks		<input type="checkbox"/>	<input type="checkbox"/>	<input type="checkbox"/>	<input type="checkbox"/>	<input type="checkbox"/>	<input type="checkbox"/>	<input type="checkbox"/>																																																																																																							
	4"Caster & Springs			<input type="checkbox"/>	<input type="checkbox"/>	<input type="checkbox"/>	<input type="checkbox"/>	<input type="checkbox"/>	<input type="checkbox"/>																																																																																																							
	4"Caster & Frog Legs			<input type="checkbox"/> *	<input type="checkbox"/> *	<input type="checkbox"/> *	<input type="checkbox"/> *	<input type="checkbox"/> *	<input type="checkbox"/> *	<input type="checkbox"/> *																																																																																																						
	5"Caster & STD Forks				<input type="checkbox"/> *	<input type="checkbox"/>	<input type="checkbox"/>	<input type="checkbox"/>	<input type="checkbox"/>	<input type="checkbox"/> *																																																																																																						
	5"Caster & Springs				<input type="checkbox"/> *	<input type="checkbox"/> *	<input type="checkbox"/> *	<input type="checkbox"/> *	<input type="checkbox"/> *	<input type="checkbox"/> *																																																																																																						
5"Caster & Frog Legs					<input type="checkbox"/> *	<input type="checkbox"/> *	<input type="checkbox"/> *	<input type="checkbox"/> *	<input type="checkbox"/> *																																																																																																							
8. REAR SEAT HEIGHT	<input type="checkbox"/> 12.5" <input type="checkbox"/> 13.0" <input type="checkbox"/> 13.5" <input type="checkbox"/> 14.0" <input type="checkbox"/> 14.5" <input type="checkbox"/> 15.0" <input type="checkbox"/> 15.5" <input type="checkbox"/> 16.0" <input type="checkbox"/> 16.5" <input type="checkbox"/> 17.0" <input type="checkbox"/> 17.5"	\$ STD																																																																																																														
STD Rear Seat Height Ranges *No Custom Modifications	<table border="1" style="width:100%; border-collapse: collapse;"> <thead> <tr> <th>Rear Tire Size</th> <th>Rear Seat Height</th> </tr> </thead> <tbody> <tr> <td>20"x1"(451)</td> <td>12.5"- 16.0"</td> </tr> <tr> <td>20"x1 3/8"(451)</td> <td>13.0"- 16.5"</td> </tr> <tr> <td>22"x1"(501)</td> <td>13.5"- 17.0"</td> </tr> <tr> <td>22"x1 3/8"(501)</td> <td>14.0"- 17.5"</td> </tr> </tbody> </table>	Rear Tire Size	Rear Seat Height	20"x1"(451)	12.5"- 16.0"	20"x1 3/8"(451)	13.0"- 16.5"	22"x1"(501)	13.5"- 17.0"	22"x1 3/8"(501)	14.0"- 17.5"																																																																																																					
Rear Tire Size	Rear Seat Height																																																																																																															
20"x1"(451)	12.5"- 16.0"																																																																																																															
20"x1 3/8"(451)	13.0"- 16.5"																																																																																																															
22"x1"(501)	13.5"- 17.0"																																																																																																															
22"x1 3/8"(501)	14.0"- 17.5"																																																																																																															
9. CENTER OF GRAVITY	<input type="checkbox"/> 0.0" <input type="checkbox"/> 0.5" <input type="checkbox"/> 1.0" <input type="checkbox"/> 1.5" <input type="checkbox"/> 2.0" <input type="checkbox"/> 2.5" <input type="checkbox"/> 3.0" <input type="checkbox"/> 3.5" <input type="checkbox"/> 4.0" <input type="checkbox"/> 4.5"	\$ STD																																																																																																														
Center of Gravity Ranges ☆=Not Available 4" and 5" Caster. ★=Not Available 22" Wheel. △=Not Available Scissor Lock	<table border="1" style="width:100%; border-collapse: collapse;"> <thead> <tr> <th colspan="2" rowspan="2"></th> <th colspan="10">Your Center of Gravity</th> </tr> <tr> <th>0"</th> <th>0.5"</th> <th>1.0"</th> <th>1.5"</th> <th>2.0"</th> <th>2.5"</th> <th>3.0"</th> <th>3.5"</th> <th>4.0"</th> <th>4.5"</th> </tr> </thead> <tbody> <tr> <td rowspan="6" style="writing-mode: vertical-rl; transform: rotate(180deg);">Your Seat Depth</td> <td>10"</td> <td><input type="checkbox"/>☆</td> <td><input type="checkbox"/>☆★</td> <td></td> <td></td> <td></td> <td></td> <td></td> <td></td> <td></td> <td></td> </tr> <tr> <td>11"</td> <td><input type="checkbox"/>☆</td> <td><input type="checkbox"/>☆</td> <td><input type="checkbox"/>☆</td> <td><input type="checkbox"/>☆★</td> <td></td> <td></td> <td></td> <td></td> <td></td> <td></td> </tr> <tr> <td>12"</td> <td><input type="checkbox"/>△</td> <td><input type="checkbox"/></td> <td><input type="checkbox"/>☆</td> <td><input type="checkbox"/>☆</td> <td><input type="checkbox"/>☆</td> <td><input type="checkbox"/>☆★</td> <td></td> <td></td> <td></td> <td></td> </tr> <tr> <td>13"</td> <td><input type="checkbox"/>△</td> <td><input type="checkbox"/>△</td> <td><input type="checkbox"/></td> <td><input type="checkbox"/></td> <td><input type="checkbox"/>☆</td> <td><input type="checkbox"/>☆</td> <td><input type="checkbox"/>☆</td> <td><input type="checkbox"/>☆★</td> <td></td> <td></td> </tr> <tr> <td>14"</td> <td><input type="checkbox"/>△</td> <td><input type="checkbox"/>△</td> <td><input type="checkbox"/></td> <td><input type="checkbox"/></td> <td><input type="checkbox"/></td> <td><input type="checkbox"/></td> <td><input type="checkbox"/></td> <td><input type="checkbox"/>☆</td> <td><input type="checkbox"/>☆</td> <td><input type="checkbox"/>☆★</td> </tr> <tr> <td>15"</td> <td><input type="checkbox"/>△</td> <td><input type="checkbox"/>△</td> <td><input type="checkbox"/>△</td> <td><input type="checkbox"/>△</td> <td><input type="checkbox"/></td> <td><input type="checkbox"/></td> <td><input type="checkbox"/></td> <td><input type="checkbox"/></td> <td><input type="checkbox"/></td> <td><input type="checkbox"/>☆</td> </tr> </tbody> </table>			Your Center of Gravity										0"	0.5"	1.0"	1.5"	2.0"	2.5"	3.0"	3.5"	4.0"	4.5"	Your Seat Depth	10"	<input type="checkbox"/> ☆	<input type="checkbox"/> ☆★									11"	<input type="checkbox"/> ☆	<input type="checkbox"/> ☆	<input type="checkbox"/> ☆	<input type="checkbox"/> ☆★							12"	<input type="checkbox"/> △	<input type="checkbox"/>	<input type="checkbox"/> ☆	<input type="checkbox"/> ☆	<input type="checkbox"/> ☆	<input type="checkbox"/> ☆★					13"	<input type="checkbox"/> △	<input type="checkbox"/> △	<input type="checkbox"/>	<input type="checkbox"/>	<input type="checkbox"/> ☆	<input type="checkbox"/> ☆	<input type="checkbox"/> ☆	<input type="checkbox"/> ☆★			14"	<input type="checkbox"/> △	<input type="checkbox"/> △	<input type="checkbox"/>	<input type="checkbox"/>	<input type="checkbox"/>	<input type="checkbox"/>	<input type="checkbox"/>	<input type="checkbox"/> ☆	<input type="checkbox"/> ☆	<input type="checkbox"/> ☆★	15"	<input type="checkbox"/> △	<input type="checkbox"/> △	<input type="checkbox"/> △	<input type="checkbox"/> △	<input type="checkbox"/>	<input type="checkbox"/>	<input type="checkbox"/>	<input type="checkbox"/>	<input type="checkbox"/>	<input type="checkbox"/> ☆																						
				Your Center of Gravity																																																																																																												
		0"	0.5"	1.0"	1.5"	2.0"	2.5"	3.0"	3.5"	4.0"	4.5"																																																																																																					
Your Seat Depth	10"	<input type="checkbox"/> ☆	<input type="checkbox"/> ☆★																																																																																																													
	11"	<input type="checkbox"/> ☆	<input type="checkbox"/> ☆	<input type="checkbox"/> ☆	<input type="checkbox"/> ☆★																																																																																																											
	12"	<input type="checkbox"/> △	<input type="checkbox"/>	<input type="checkbox"/> ☆	<input type="checkbox"/> ☆	<input type="checkbox"/> ☆	<input type="checkbox"/> ☆★																																																																																																									
	13"	<input type="checkbox"/> △	<input type="checkbox"/> △	<input type="checkbox"/>	<input type="checkbox"/>	<input type="checkbox"/> ☆	<input type="checkbox"/> ☆	<input type="checkbox"/> ☆	<input type="checkbox"/> ☆★																																																																																																							
	14"	<input type="checkbox"/> △	<input type="checkbox"/> △	<input type="checkbox"/>	<input type="checkbox"/>	<input type="checkbox"/>	<input type="checkbox"/>	<input type="checkbox"/>	<input type="checkbox"/> ☆	<input type="checkbox"/> ☆	<input type="checkbox"/> ☆★																																																																																																					
	15"	<input type="checkbox"/> △	<input type="checkbox"/> △	<input type="checkbox"/> △	<input type="checkbox"/> △	<input type="checkbox"/>	<input type="checkbox"/>	<input type="checkbox"/>	<input type="checkbox"/>	<input type="checkbox"/>	<input type="checkbox"/> ☆																																																																																																					
10. CAMBER ANGLE	<input type="checkbox"/> 2° <input type="checkbox"/> 4° <input type="checkbox"/> 6°	\$ STD																																																																																																														
11. FRONT OF SEAT SLING TO FOOTREST	<input type="checkbox"/> 12.5" <input type="checkbox"/> 13.0" <input type="checkbox"/> 13.5" <input type="checkbox"/> 14.0" <input type="checkbox"/> 14.5" <input type="checkbox"/> 15.0" <input type="checkbox"/> 15.5" <input type="checkbox"/> 16.0" <input type="checkbox"/> 16.5" <input type="checkbox"/> 17.0"	\$ STD																																																																																																														
*Measurement must be 1.5" shorter than your Front Seat Height																																																																																																																
HIGH MOUNT	<input type="checkbox"/> 6.0" <input type="checkbox"/> 6.5" <input type="checkbox"/> 7.0" <input type="checkbox"/> 7.5" <input type="checkbox"/> 8.0" <input type="checkbox"/> 8.5" <input type="checkbox"/> 9.0" <input type="checkbox"/> 9.5" <input type="checkbox"/> 10.0" <input type="checkbox"/> 10.5" <input type="checkbox"/> 11.0" <input type="checkbox"/> 11.5" <input type="checkbox"/> 12.0"	\$ 65																																																																																																														
With Risers or Clamps																																																																																																																
12. INSIDE WHEEL CLEARANCE	<input type="checkbox"/> 3/4" * <input type="checkbox"/> 1" <input type="checkbox"/> 1 1/4" <input type="checkbox"/> 1 1/2" <input type="checkbox"/> 1 3/4" <input type="checkbox"/> 2"	\$ STD																																																																																																														
*3/4" Inside wheel clearance not available with 2 degree camber. (with the exception of Y-360 wheels) *3/4" Inside wheel clearance not available with Armrest *3/4" Inside wheel clearance not available with D's Locks																																																																																																																
NOTE																																																																																																																
Sub Total Section B 1/2		\$																																																																																																														
Sub Total Section B 2/2		\$																																																																																																														
Total Section B		\$																																																																																																														

C WHEELS, TIRES & CASTERS, FORKS 1/2

WHEELS															
Standard Radial Spoke Wheel	<input type="checkbox"/> 20" (451) <input type="checkbox"/> 22" (501)		\$ STD												
Mag Wheel w/Chrome Handrims (Long Tab Only)	<input type="checkbox"/> 20" (451) <input type="checkbox"/> 22" (501)		\$ STD												
Twister Super Strength wheel	<input type="checkbox"/> 20" (451) <input type="checkbox"/> 22" (501)		\$ 300												
Spinergy Spox 18 Spokes	<input type="checkbox"/> 22" (501) Spoke Color <input type="checkbox"/> Black <input type="checkbox"/> Red <input type="checkbox"/> Yellow <input type="checkbox"/> Blue <input type="checkbox"/> White	<small>With Silver Hub With Black Hub With Black Hub With Black Hub With Black Hub</small>	\$ 695												
	<input type="checkbox"/> Custom Color Spoke Pattern	<table border="1"> <tr> <td></td> <td>Left Wheel</td> <td>Right Wheel</td> </tr> <tr> <td>Spokes</td> <td></td> <td></td> </tr> <tr> <td>Color</td> <td></td> <td></td> </tr> <tr> <td>Hub Color</td> <td><input type="checkbox"/> Black/<input type="checkbox"/> Silver</td> <td><input type="checkbox"/> Black/<input type="checkbox"/> Silver</td> </tr> </table>		Left Wheel	Right Wheel	Spokes			Color			Hub Color	<input type="checkbox"/> Black/ <input type="checkbox"/> Silver	<input type="checkbox"/> Black/ <input type="checkbox"/> Silver	\$ 795
		Left Wheel	Right Wheel												
Spokes															
Color															
Hub Color	<input type="checkbox"/> Black/ <input type="checkbox"/> Silver	<input type="checkbox"/> Black/ <input type="checkbox"/> Silver													
Spinergy LX 12 Spokes	<input type="checkbox"/> 22" (501) Spoke Color <input type="checkbox"/> Black <input type="checkbox"/> Red <input type="checkbox"/> Yellow <input type="checkbox"/> Blue <input type="checkbox"/> White	<small>With Silver Hub With Black Hub With Black Hub With Black Hub With Black Hub</small>	\$ 895												
	<input type="checkbox"/> Custom Color Spoke Pattern	<table border="1"> <tr> <td></td> <td>Left Wheel</td> <td>Right Wheel</td> </tr> <tr> <td>Spokes</td> <td></td> <td></td> </tr> <tr> <td>Color</td> <td></td> <td></td> </tr> <tr> <td>Hub Color</td> <td><input type="checkbox"/> Black/<input type="checkbox"/> Silver</td> <td><input type="checkbox"/> Black/<input type="checkbox"/> Silver</td> </tr> </table>		Left Wheel	Right Wheel	Spokes			Color			Hub Color	<input type="checkbox"/> Black/ <input type="checkbox"/> Silver	<input type="checkbox"/> Black/ <input type="checkbox"/> Silver	\$ 995
		Left Wheel	Right Wheel												
Spokes															
Color															
Hub Color	<input type="checkbox"/> Black/ <input type="checkbox"/> Silver	<input type="checkbox"/> Black/ <input type="checkbox"/> Silver													
Pro Wheels	<input type="checkbox"/> 20" (451) <input type="checkbox"/> 22" (501)	Spoke & Handrim Color <input type="checkbox"/> Anodized Black <input type="checkbox"/> Anodized Red <input type="checkbox"/> Anodized Blue	\$ 825												
Wijit Drive System	*Call for availability		\$ 5,488												
HANDRIMS															
Type	<input type="checkbox"/> Standard For 20", 22" Wheel Anodized Black *Not available with Mag wheel, Pro wheels		\$ STD												
	<input type="checkbox"/> Vinyl Coated For 20", 22" Wheel *Not available with Mag wheel, Pro wheels		\$ 142												
	<input type="checkbox"/> Natural Fit For 22" Wheel Only *not available with Mag wheel.														
	<input type="checkbox"/> Standard Grip (Not available with short tabs.)		\$ 295												
	<input type="checkbox"/> Super Grip (Not available with short tabs.)		\$ 340												
	<input type="checkbox"/> Without Thumb Grip		\$ 270												
	<input type="checkbox"/> Natural Fit (LT) For 22" Wheel Only *not available with Mag wheel.														
	<input type="checkbox"/> Standard Grip (Not available with short tabs.)		\$ 325												
<input type="checkbox"/> Super Grip (Not available with short tabs.)		\$ 370													
<input type="checkbox"/> Without Thumb Grip		\$ 300													
<input type="checkbox"/> The Surge Handrims *not available with Mag wheel.		\$ 315													
<input type="checkbox"/> The Surge Handrims (LT) *not available with Mag wheel.		\$ 340													
TAB LENGTH	<input type="checkbox"/> Long Tabs(STD inside clearance 3/4")		\$ STD												
	<input type="checkbox"/> Short Tabs(Inside clearance 1/2") *Not available with Mag wheel		\$ STD												
	<input type="checkbox"/> Short Tab (Set closest to wheel cut off excess)		\$ 15												
*Not available with Mag Wheel, Pro Wheel.															
NOTE															

C WHEELS, TIRES & CASTERS, FORKS 2/2

TIRES			
<input type="checkbox"/> Low Pressure Tire	<input type="checkbox"/> 20"x1-3/8" or <input type="checkbox"/> 22"x1-3/8"	Gray Only	E2211/E2212 \$ STD
<input type="checkbox"/> High Pressure Tire	22"x1"	Gray Tire with black wall Only	E2211/E2212 \$ NCO
<input type="checkbox"/> Solid Tire	<input type="checkbox"/> 20"x1", <input type="checkbox"/> 22"x1"	<input type="checkbox"/> Dark Gray <input type="checkbox"/> Black(\$30up charge)	E2218 \$ 135
<input type="checkbox"/> E2213 Flat-Free Inserts	For 20"x1-3/8" or 22"x1-3/8" Tires Only		E2211/E2213 \$ 117

CASTERS					
SIZE	TIRE WIDTH	HUB COLOR	TIRE COLOR	DESCRIPTION	
<input type="checkbox"/> 3"	1"	Black Hub	Black Tire Only	Polyurethane	\$ STD
<input type="checkbox"/> 3"	1"	Plastic Black Hub	Clear Tire Only	Lighted, Polyurethane	\$ 65
<input type="checkbox"/> 3"	1"	Red Hub	Red Tire Only	Polyurethane	\$ STD
<input type="checkbox"/> 3"	1"	Black Hub	Clear Tire Only	Polyurethane	\$ STD
<input type="checkbox"/> 3"	1"	Aluminum Silver Hub	Black Tire Only	Made By Flog Legs	\$ 165
<input type="checkbox"/> 3"	1"	Aluminum Black Hub	Black Tire Only	Made By Flog Legs	\$ 165
<input type="checkbox"/> 3"	1.5"	Aluminum Silver Hub	Black Tire Only	Soft Roll Made By Flog Legs	\$ 165
<input type="checkbox"/> 3"	1.5"	Aluminum Black Hub	Black Tire Only	Soft Roll Made By Flog Legs	\$ 165
<input type="checkbox"/> 4"	1"	Plastic Black Hub	Black Tire Only		\$ STD
<input type="checkbox"/> 4"	1"	Plastic Black Hub	Clear Only	Lighted, Polyurethane	\$ 65
<input type="checkbox"/> 4"	1"	Plastic Black Hub	Black Tire Only	Made By Flog Legs	\$ 125
<input type="checkbox"/> 4"	1"	Aluminum Silver Hub	Black Tire Only	Made By Flog Legs	\$ 165
<input type="checkbox"/> 4"	1"	Aluminum Black Hub	Black Tire Only	Made By Flog Legs	\$ 165
<input type="checkbox"/> 4"	1.5"	Composite Black Hub	Tire <input type="checkbox"/> Black <input type="checkbox"/> Blue <input type="checkbox"/> Red	Soft Roll Made By Flog Legs	\$ 125
<input type="checkbox"/> 4"	1.5"	Aluminum Silver Hub	Tire <input type="checkbox"/> Black <input type="checkbox"/> Blue <input type="checkbox"/> Red	Soft Roll Made By Flog Legs	\$ 165
<input type="checkbox"/> 4"	1.5"	Aluminum Black Hub	Black Tire Only	Soft Roll Made By Flog Legs	\$ 165
<input type="checkbox"/> 5"	1"	Composite Black Hub	Black Tire Only		\$ STD
<input type="checkbox"/> 5"	1"	Plastic Black Hub	Clear Tire Only	Lighted, Polyurethane	\$ 65
<input type="checkbox"/> 5"	1"	Composite Black Hub	Black Tire Only	Made By Flog Legs	\$ 125
<input type="checkbox"/> 5"	1"	Aluminum Silver Hub	Black Tire Only	Made By Flog Legs	\$ 165
<input type="checkbox"/> 5"	1"	Aluminum Black Hub	Black Tire Only	Made By Flog Legs	\$ 165
<input type="checkbox"/> 5"	1.5"	Composite Black Hub	Tire <input type="checkbox"/> Black <input type="checkbox"/> Blue <input type="checkbox"/> Red	Soft Roll Made By Flog Legs	\$ 135
<input type="checkbox"/> 5"	1.5"	Aluminum Silver Hub	Tire <input type="checkbox"/> Black <input type="checkbox"/> Blue <input type="checkbox"/> Red	Soft Roll Made By Flog Legs	\$ 165
<input type="checkbox"/> 5"	1.5"	Aluminum Black Hub	Black Tire Only	Soft Roll Made By Flog Legs	\$ 165

FORKS			
<input type="checkbox"/> STD Aluminum Forks	Black Only		\$ STD
Extra Options for Aluminum Forks	<input type="checkbox"/> With Suspension		E1015 \$ 55
	<input type="checkbox"/> With Quick Release Axles		K0073 \$ 107
<input type="checkbox"/> Frog Leg Suspension Forks	Std 1" Wide (For 3", 4" x 1" width Caster and 5" lighted Caster)	(Not available with Quick Release Axles)	
	Color <input type="checkbox"/> Anodized Black <input type="checkbox"/> Anodized Silver		E1015 \$ 575
<input type="checkbox"/> Frog Leg Suspension Forks	1.5" Wide (For 3", 4" x 1.5" width Caster and 5" Caster)	(Not available with Quick Release Axles)	
	Color <input type="checkbox"/> Anodized Black <input type="checkbox"/> Anodized Silver		E1015 \$ 575

Sub Total Section C 1/2	\$
Sub Total Section C 2/2	\$
Total Section C	\$

D COMPONENTS

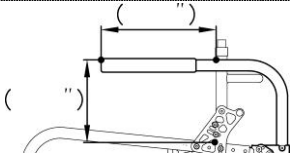
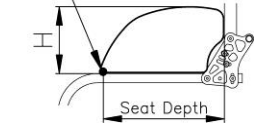
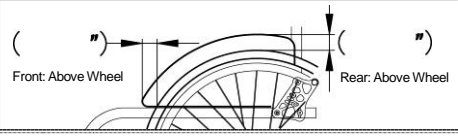
WHEEL LOCKS								
<input type="checkbox"/> Push to Lock / Anodized Black Only		\$ STD						
<input type="checkbox"/> NEW Compact Push to Lock / Anodized Black Only <input type="checkbox"/> w/ 2" Extension Handle (\$65up)		\$ 110						
<input type="checkbox"/> NEW Compact Scissor Lock / Anodized Black Only		\$ 110						
<input type="checkbox"/> D's Locks (*Not available with X-Core, Topolino WX2.5, Pro Wheels) (*Does not include installation fee)		\$ CFP						
PUSH HANDLES *If you are ordering push handles, You must select the backrest locking mechanism.								
<input type="checkbox"/> Integrated w/Fixed Backrest Height / Anodized Black Only		\$ STD						
<input type="checkbox"/> Bolt-on / Anodized Black Only Specify Height from floor -()		\$ 142						
<input type="checkbox"/> Bolt-on w/Quick Release / Anodized Black Only Specify Height from floor -()		\$ 190						
<input type="checkbox"/> NEW Height Adj. / Anodized Black Only Specify Maximum height from floor -()		\$ 295						
NEW ARM RESTS Anodized Black Only,								
<input type="checkbox"/> Fixed Tubular Armrest Adj. Angle and Height Height from seat sling Set at : <input type="checkbox"/> 8" <input type="checkbox"/> 9" <input type="checkbox"/> 10" <input type="checkbox"/> 11" <input type="checkbox"/> 12" E0973		\$ 250						
<input type="checkbox"/> Swing Away Tubular Armrest Adj. Angle and Height Height from seat sling Set at : <input type="checkbox"/> 8" <input type="checkbox"/> 9" <input type="checkbox"/> 10" <input type="checkbox"/> 11" <input type="checkbox"/> 12" E0973		\$ 250						
<input type="checkbox"/> Flip-Up Armrest <input type="checkbox"/> w/Fixed Tubular Armrest Height from seat sling Set at : <input type="checkbox"/> 8" <input type="checkbox"/> 9" <input type="checkbox"/> 10" <input type="checkbox"/> 11" <input type="checkbox"/> 12" E0973		\$ 250						
Adj. Angle <input type="checkbox"/> w/ Swing Away Tubular Armrest Height from seat sling Set at : <input type="checkbox"/> 8" <input type="checkbox"/> 9" <input type="checkbox"/> 10" <input type="checkbox"/> 11" <input type="checkbox"/> 12" E0973		\$ 250						
<input type="checkbox"/> Custom Length & Height (\$150 up charge) *Specify Height & Length →								
ANTI-TIPPERS								
<input type="checkbox"/> Anti-Tippers (pair) w/ Quick Release / Anodized Black Only	E0971	\$ 112						
SIDE GUARDS								
<input type="checkbox"/> Rigid Side Guards - Black ABS <input type="checkbox"/> Non-Removable <input type="checkbox"/> Removable <input type="checkbox"/> Removable w/Hole (\$10 up charge)	Size: <input type="checkbox"/> STD <input type="checkbox"/> Medium <input type="checkbox"/> Cut to Wheel (\$98 up charge)	Measurement						
	Color: Black Only							
<input type="checkbox"/> Rigid Side Guards - Aluminum <input type="checkbox"/> Non-Removable <input type="checkbox"/> Removable	Size: <input type="checkbox"/> Medium Only <input type="checkbox"/> Cut to Wheel (\$98 up charge)	Measurement						
Front of Seat	Color <input type="checkbox"/> Black (STD) <input type="checkbox"/> Pol. Aluminum (STD)							
	<input type="checkbox"/> Powder Coated () (\$50 up charge)							
<table border="1" data-bbox="186 1165 414 1249"> <tr> <th>Height</th> <th>Size</th> </tr> <tr> <td>7.5"</td> <td>STD</td> </tr> <tr> <td>8.25"</td> <td>Medium</td> </tr> </table>	Height	Size	7.5"	STD	8.25"	Medium	<input type="checkbox"/> Gold Plate (+CFP)	
Height	Size							
7.5"	STD							
8.25"	Medium							
<input type="checkbox"/> PRO-TEX Fender Guards / (Black ABS -Only) <input type="checkbox"/> Cut to Fit Specs <input type="checkbox"/> Do Not Install		\$ 175						
<input type="checkbox"/> Fabric Clothing Guards Black Nylon w/Velcro		\$ 78						
SEAT CUSHION -*Please see section E for other cushion choices.-								
<input type="checkbox"/> Foam Cushion w/Nylon Black Cover Thickness <input type="checkbox"/> 1" <input type="checkbox"/> 2" <input type="checkbox"/> 3" <input type="checkbox"/> 4"		\$ 78						
<input type="checkbox"/> Custom Cushion Cover (Std. Foam Cushion Only)—Select Fabric ()								
MISCELLANEOUS								
<input type="checkbox"/> Frame Protectors / Black Leather/Zipper Type		\$ 78						
<input type="checkbox"/> K0065 Spoke Protectors / Black Only <input type="checkbox"/> 24" <input type="checkbox"/> 25" <input type="checkbox"/> 26"	K0065	\$ 107						
<input type="checkbox"/> E0978 Seat Belt w/Auto Buckle (BP) 1.5" Black Belt Only	E0978	\$ 69						
<input type="checkbox"/> Tie Down Brackets 4pcs.		\$ 210						
SPECIALTY PARTS <input type="checkbox"/> Wheelchair Tray Size: <input type="checkbox"/> W14"x D12" <input type="checkbox"/> W16"x D14" <input type="checkbox"/> W18"x D14"								
	Color: <input type="checkbox"/> Raw Alum. <input type="checkbox"/> Black Alum. <input type="checkbox"/> Polish Alum. (\$250 up charge)	\$ 250						
UPHOLSTERY CHOICE & COLOR *Positioning Back Available. Please see Section E								
<input type="checkbox"/> Standard Adjustable Ht Backrest Black Only		\$ STD						
<input type="checkbox"/> Adjustable Tension Backrest Black Only (*Not available with 8" Backrest Height)		\$ 135						
Custom Options <input type="checkbox"/> Fabrics for Fun <input type="checkbox"/> 001 <input type="checkbox"/> 002 <input type="checkbox"/> 003 <input type="checkbox"/> 004 <input type="checkbox"/> 006 <input type="checkbox"/> 010 <input type="checkbox"/> 011		(\$95 up charge)						
	For Std. or Adj. Style <input type="checkbox"/> 014 <input type="checkbox"/> 015 <input type="checkbox"/> 016 <input type="checkbox"/> 017 <input type="checkbox"/> 018 <input type="checkbox"/> 020 <input type="checkbox"/> 021							
	<input type="checkbox"/> 022 <input type="checkbox"/> 023 <input type="checkbox"/> 024 <input type="checkbox"/> 025 <input type="checkbox"/> 026 <input type="checkbox"/> 027 <input type="checkbox"/> 028							
<input type="checkbox"/> Backrest Leather Trim (outside panels)		(\$77 up charge)						
<input type="checkbox"/> Calf Strap <input type="checkbox"/> Black <input type="checkbox"/> Matching Fabric (\$55 up charge) -Select Fabric()	K0038	\$ 24						
<input type="checkbox"/> Matching Fabric on Padded Side Guards -Select Fabric ()		\$ 210						
Total Section D		\$						

E CHAIR OPTIONS 1/2

SEAT CUSHION				
SUPRACOR® WHEELCHAIR CUSHIONS				
Stimulite® Contoured Cushion *Black Upholstery only	<input type="checkbox"/> W14"xD16" (CD1416)	E2603 \$ 525	
	<input type="checkbox"/> W16"xD16" (CD1616)	E2603 \$ 525	
	<input type="checkbox"/> W16"xD18" (CD1618)	E2603 \$ 525	
	<input type="checkbox"/> W18"xD16" (CD1816)	E2603 \$ 525	
	<input type="checkbox"/> W18"xD18" (CD1818)	E2603 \$ 525	
	<input type="checkbox"/> W18"xD20" (CD1820)	E2603 \$ 540	
	<input type="checkbox"/> W20"xD16" (CD2016)	E2603 \$ 540	
	<input type="checkbox"/> W20"xD18" (CD2018)	E2603 \$ 540	
	<input type="checkbox"/> W20"xD20" (CD2020)	E2603 \$ 555	
			<input type="checkbox"/> Extra Sensitive (\$30 up charge) <input type="checkbox"/> Sling Style Bottom (\$45 up charge) <input type="checkbox"/> Custom Size W(") x D(") (-\$ CFP)	
Stimulite® Slimline Cushion *Black Upholstery only	<input type="checkbox"/> W14"xD16" (SM1416)	E2603 \$ 495	
	<input type="checkbox"/> W16"xD16" (SM1616)	E2603 \$ 495	
	<input type="checkbox"/> W16"xD18" (SM1618)	E2603 \$ 495	
	<input type="checkbox"/> W18"xD18" (SM1818)	E2603 \$ 495	
	<input type="checkbox"/> W18"xD20" (SM1820)	E2603 \$ 495	
	<input type="checkbox"/> W20"xD16" (SM2016)	E2603 \$ 510	
	<input type="checkbox"/> W20"xD18" (SM2018)	E2603 \$ 510	
	<input type="checkbox"/> W20"xD20" (SM2020)	E2603 \$ 510	
			<input type="checkbox"/> Extra Sensitive (\$30 up charge) <input type="checkbox"/> Sling Style Bottom (\$45 up charge) <input type="checkbox"/> Custom Size W(") x D(") (-\$ CFP)	
	Stimulite® Corbee Pediatric *Black Upholstery only	<input type="checkbox"/> W10"xD10" (PD1010)	E2603 \$ 450
<input type="checkbox"/> W12"xD12" (PD1212)		E2603 \$ 450	
<input type="checkbox"/> W14"xD14" (PD1414)		E2603 \$ 450	
		<input type="checkbox"/> Extra Sensitive (\$30 up charge) <input type="checkbox"/> Sling Style Bottom (\$45 up charge) <input type="checkbox"/> Custom Size W(") x D(") (-\$ CFP)		
ROHO WHEELCHAIR CUSHIONS				
Choose Size	<input type="checkbox"/> 4" HIGH PROFILE® QUADTRO SELECT® CUSHION *Black Upholstery		E2622-2623 \$ 525	
	<input type="checkbox"/> W12"xD12"	<input type="checkbox"/> W12"xD13"	<input type="checkbox"/> W13"xD13"	
	<input type="checkbox"/> W15"xD16"	<input type="checkbox"/> W15"xD18"	<input type="checkbox"/> W16"xD15"	
	<input type="checkbox"/> W18"xD16"	<input type="checkbox"/> W18"xD18"	<input type="checkbox"/> W18"xD20"	
	<input type="checkbox"/> W20"xD22"	<input type="checkbox"/> W22"xD18"	<input type="checkbox"/> W22"xD20"	
		<input type="checkbox"/> W13"xD15" <input type="checkbox"/> W13"xD16" <input type="checkbox"/> W15"xD13" <input type="checkbox"/> W15"xD15" <input type="checkbox"/> W16"xD16" <input type="checkbox"/> W16"xD18" <input type="checkbox"/> W16"xD20" <input type="checkbox"/> W18"xD15" <input type="checkbox"/> W18"xD22" <input type="checkbox"/> W20"xD16" <input type="checkbox"/> W20"xD18" <input type="checkbox"/> W20"xD20" <input type="checkbox"/> Custom Size W(") x D(") (+\$85)		
Choose Size	<input type="checkbox"/> 3" MID PROFILE® QUADTRO SELECT® CUSHION *Black Upholstery only		E2622-2623 \$ 525	
	<input type="checkbox"/> W15"xD15"	<input type="checkbox"/> W15"xD16"	<input type="checkbox"/> W16"xD16"	
		<input type="checkbox"/> W16"xD18" <input type="checkbox"/> W18"xD16" <input type="checkbox"/> W18"xD18" <input type="checkbox"/> Custom Size W(") x D(") (+\$85)		
Choose Size	<input type="checkbox"/> 2" LOW PROFILE® QUADTRO SELECT® CUSHION *Black Upholstery only		E2622-2623 \$ 525	
	<input type="checkbox"/> W12"xD12"	<input type="checkbox"/> W12"xD13"	<input type="checkbox"/> W13"xD13"	
	<input type="checkbox"/> W15"xD16"	<input type="checkbox"/> W15"xD18"	<input type="checkbox"/> W16"xD15"	
	<input type="checkbox"/> W18"xD16"	<input type="checkbox"/> W18"xD18"	<input type="checkbox"/> W18"xD20"	
	<input type="checkbox"/> W20"xD16"	<input type="checkbox"/> W20"xD18"	<input type="checkbox"/> W20"xD20"	
		<input type="checkbox"/> Custom Size W(") x D(") (+\$85)		
Choose Size	<input type="checkbox"/> 2" NEXUS SPIRIT® CUSHION *Black Upholstery only		E2622 \$ 525	
	<input type="checkbox"/> W14"xD14"	<input type="checkbox"/> W14"xD16"	<input type="checkbox"/> W15"xD15"	
		<input type="checkbox"/> W16"xD16" <input type="checkbox"/> W16"xD18" <input type="checkbox"/> W17"xD17" <input type="checkbox"/> W18"xD16" * Custom Size Not Available		
STAR CUSHIONS				
Galaxy Cushion *Black Upholstery only	<input type="checkbox"/> W14"xD14" (GXY 1414-2)	<input type="checkbox"/> W14"xD16" (GXY 1416-2)	Choose Zoning Options <input type="checkbox"/> Standard - Dual Valve <input type="checkbox"/> Dual Valve - Front to Back <input type="checkbox"/> Four Valve <input type="checkbox"/> Simple - Single Valve <input type="checkbox"/> Four Valve - Enhanced <input type="checkbox"/> Four Valve - Front to Back	
	<input type="checkbox"/> W16"xD14" (GXY 1614-2)	<input type="checkbox"/> W16"xD16" (GXY 1616-2)		
	<input type="checkbox"/> W16"xD18" (GXY 1618-2)	<input type="checkbox"/> W18"xD16" (GXY 1816-2)		
	<input type="checkbox"/> W18"xD18" (GXY 1818-2)	<input type="checkbox"/> W18"xD20" (GXY 1820-2)		
	<input type="checkbox"/> W20"xD16" (GXY 2016-2)	<input type="checkbox"/> W20"xD18" (GXY 2018-2)		
	<input type="checkbox"/> W20"xD20" (GXY 2020-2)			
				E2624 \$ 498
THE CURVE CUSHION *Black Upholstery only	<input type="checkbox"/> W10"xD10"	<input type="checkbox"/> W10"xD11"	<input type="checkbox"/> W10"xD11"	
	<input type="checkbox"/> W12"xD13"	<input type="checkbox"/> W12"xD14"	<input type="checkbox"/> W13"xD11"	
	<input type="checkbox"/> W14"xD14"	<input type="checkbox"/> W14"xD15"	<input type="checkbox"/> W14"xD16"	
	<input type="checkbox"/> W16"xD14"	<input type="checkbox"/> W16"xD15"	<input type="checkbox"/> W16"xD16"	
	<input type="checkbox"/> W17"xD17"	<input type="checkbox"/> W17"xD18"	<input type="checkbox"/> W18"xD16"	
	<input type="checkbox"/> W10"xD12"	<input type="checkbox"/> W11"xD12"	<input type="checkbox"/> W12"xD12"	
<input type="checkbox"/> W13"xD12"	<input type="checkbox"/> W13"xD13"	<input type="checkbox"/> W13"xD14"		
<input type="checkbox"/> W15"xD14"	<input type="checkbox"/> W15"xD15"	<input type="checkbox"/> W15"xD16"		
<input type="checkbox"/> W16"xD17"	<input type="checkbox"/> W16"xD18"	<input type="checkbox"/> W17"xD16"		
<input type="checkbox"/> W18"xD17"	<input type="checkbox"/> W18"xD18"			
NOTE				

E CHAIR OPTIONS 2/2

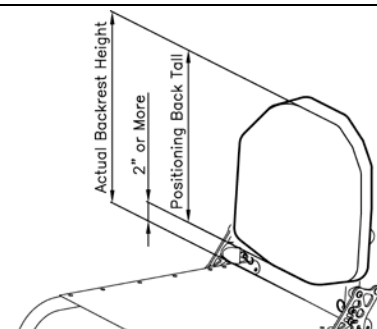
POSITIONING BACK			
<p>*Note : Actual height of the backrest will increase 2" or more.</p> 			
<p>ADI CARBON BACKREST (Support Contour-ACTIVE 2.5") *Not Available with Welded Side Guards</p> <p>Mounting Hardware: <input type="checkbox"/> 2 Point Pro <input type="checkbox"/> Quick Release</p>			
Height	<input type="checkbox"/> LOW (10" Tall) *Backrest Height requires 12" or more *Available 13"-19" width Width (") E2613	\$ 745	
	<input type="checkbox"/> Medium (13" Tall) *Backrest Height requires 15" or more *Available 13"-19" width Width (") E2613	\$ 815	
	<input type="checkbox"/> Standard (16" Tall) *Backrest Height requires 18" or more *Available 13"-19" width Width (") E2613	\$ 880	
	<input type="checkbox"/> Custom Size (" Tall) x (" width) E2613	\$ CFP	
<p>ADI ALUMINUM BACKREST (Support Contour-ACTIVE 2.5") *Not Available with Welded Side Guards</p> <p>Mounting Hardware: <input type="checkbox"/> 2 Point Pro <input type="checkbox"/> Quick Release</p>			
Height	<input type="checkbox"/> LOW (10" Tall) *Backrest Height requires 12" or more *Available 10"-20" width Width (") E2613	\$ 610	
	<input type="checkbox"/> Medium (13" Tall) *Backrest Height requires 15" or more *Available 12"-20" width Width (") E2613	\$ 625	
	<input type="checkbox"/> Standard (16" Tall) *Backrest Height requires 18" or more *Available 14"-20" width Width (") E2613	\$ 640	
	<input type="checkbox"/> Tall (18" Tall) *Backrest Height requires 20" or more *Available 16"-20" width Width (") E2613	\$ 655	
	<input type="checkbox"/> X-Tall (20" Tall) *Backrest Height requires 22" or more *Available 16"-20" width Width (") E2613	\$ 670	
	<input type="checkbox"/> Custom Size (" Tall) x (" width) E2613	\$ CFP	
<p>ADI ALUMINUM BACKREST (Support Contour-DEEP 4") *Not Available with Welded Side Guards *Not Available with Lateral Supports</p> <p>Mounting Hardware: <input type="checkbox"/> 2 Point Pro <input type="checkbox"/> Quick Release</p>			
Height	<input type="checkbox"/> LOW (10" Tall) *Backrest Height requires 12" or more *Available 10"-20" width Width (") E2615	\$ 710	
	<input type="checkbox"/> Medium (13" Tall) *Backrest Height requires 15" or more *Available 12"-20" width Width (") E2615	\$ 725	
	<input type="checkbox"/> Standard (16" Tall) *Backrest Height requires 18" or more *Available 14"-20" width Width (") E2615	\$ 740	
	<input type="checkbox"/> Tall (18" Tall) *Backrest Height requires 20" or more *Available 16"-20" width Width (") E2615	\$ 755	
	<input type="checkbox"/> X-Tall (20" Tall) *Backrest Height requires 22" or more *Available 16"-20" width Width (") E2615	\$ 770	
	<input type="checkbox"/> Custom Size (" Tall) x (" width) E2615	\$ CFP	
<p>ADI LATERAL SUPPORTS (Lateral Supports are compatible with only active 2.5" ADI positioning back.)</p>			
<input type="checkbox"/> Stationary Pad Pad Size <input type="checkbox"/> Small (3" H x 3" D) <input type="checkbox"/> Medium(3" H x 4" D) <input type="checkbox"/> Large(4.5" H x 4.5" D) <input type="checkbox"/> Large(4" H x 6" D)			
	<input type="checkbox"/> Pair 	\$ 320	
	<input type="checkbox"/> Left side only or <input type="checkbox"/> Right side only 	\$ 160	
<input type="checkbox"/> Swing-Out Pad Size <input type="checkbox"/> Small (3" H x 3" D) <input type="checkbox"/> Medium(3" H x 4" D) <input type="checkbox"/> Large(4.5" H x 4.5" D) <input type="checkbox"/> Large(4" H x 6" D)			
	<input type="checkbox"/> Pair 	\$ 520	
	<input type="checkbox"/> Left side only or <input type="checkbox"/> Right side only 	\$ 260	
<p>OTHER</p>			
<input type="checkbox"/> ADI Transfer Board <input type="checkbox"/> 21" (ADV21) <input type="checkbox"/> 24" (ADV24) <input type="checkbox"/> 29" 		\$ 62	
<input type="checkbox"/> ADI Push and Transfer Gloves Leather (one size fits) 		\$ 60	
<input type="checkbox"/> ADI Carbon Solid Seat (Wide: 18" Max, Depth: 20") *Colours Side Guards Not Available with ADI Carbon Solid Seat		\$ 625	
<input type="checkbox"/> With / <input type="checkbox"/> ADI Folding Carbon Side Guard		\$ 400	
<input type="checkbox"/> With / <input type="checkbox"/> ADI Fixed Carbon Side Guard		\$ 375	
<p>VARILITE® Seating Systems Available</p> <p style="text-align: right;">Please visit for all options. www.varilite.com</p>			CFP
<p>NOTE</p>			
Sub Total Section E 1/2			\$
Sub Total Section E 2/2			\$
Total Section E			\$

F SPECIAL PARTS COLORS (Please allow an additional 1-2 weeks delivery)

PARTS COLORS

Powder-Coated	Gloss Black	Twilight Flake	Yellow	Magenta	Fire Engine Red	White
	Candy Blue	Candy Purple	Candy Green	Candy Red	Candy Raspberry	Cobalt Blue
	Matte Gray	Matte Purple	Matte Blue	Matte Green	Matte Black	Matte Red
	Neon Red	Neon Green	Orange Sparkle	Mellon Yellow	Gun Smoke Silver	Pigeon Blue
		Granny Sparkle Green	Sparkle Sky Blue	Vermilion	Reed Green	Blue Lilac

Special Colors Polished Aluminum
24 karat Gold Plated

Please Choose the Color for each Part

*Parts not selected will be black color. (Suspension Spring: Silver Color)

*Minimum 3 parts selected per order.

*PC=Powder-Coated

Saddle Stops

- PC () \$40
- Polished \$115
- Gold Plated \$CFP

Backrest

- PC () \$125
- Polished \$225
- Gold Plated CFP

Backrest Brackets

- PC () \$90
- Polished \$115
- Gold Plated \$CFP

Foot Plate

- PC () \$45
- Polished \$90
- Gold Plated \$CFP

Footrest Rings

- PC () \$20
- Polished \$40
- Gold Plated \$CFP

Footrest Tubes

- PC () \$65
- Polished \$85
- Gold Plated \$CFP

Foot Plate Clamps

- PC () \$50
- Polished \$75
- Gold Plated \$CFP

Caps

- PC () \$20
- Polished N/A
- Gold Plated N/A

Caster Housing

- PC () \$150
- Polished \$280
- Gold Plated N/A

Front Springs

- PC () \$20
- Polished N/A
- Gold Plated N/A

Forks & Knurl Nuts

- PC () \$65
- Polished \$90
- Gold Plated \$CFP

Axle Bases

- PC () \$50
- Polished \$75
- Gold Plated \$CFP

Axle Clamps

- PC () \$50
- Polished \$75
- Gold Plated \$CFP

Axle Tube

- PC () \$50
- Polished \$75
- Gold Plated \$CFP

Axle Plates

- PC () \$65
- Polished \$85
- Gold Plated \$CFP

Camber Plates

- PC () \$50
- Polished \$75
- Gold Plated \$CFP

Total Section F \$

1. SEAT WIDTH

Measure from outside of seat tube to the outside of the opposite seat tube.

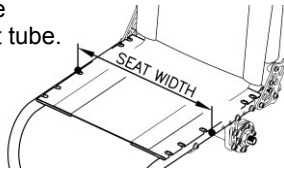

2. SEAT DEPTH

Measure from at the front bottom of backrest tube to the front edge of seat sling.

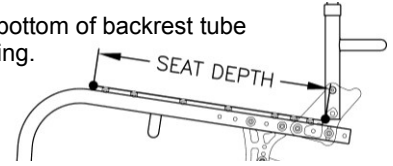

3. FOOTREST WIDTH

Measure from inside of front frame tube to inside of opposite front frame tube.

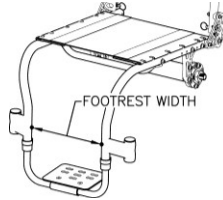

4. FRAME ANGLE

Measure angle frame front to floor.

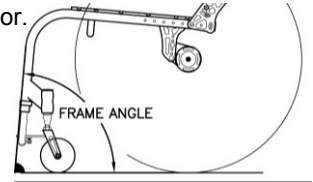

5. BACKREST HEIGHT

Measure from top of back post to seat sling at front bottom of backrest tube.

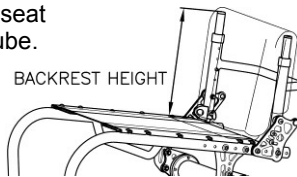

6. BACKREST ANGLE

Measure angle from front of back post to floor.

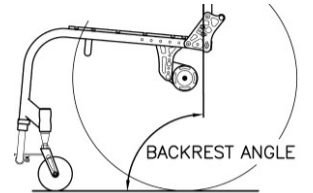

7. FRONT SEAT HEIGHT

Measure from floor to top of seat sling at front edge.

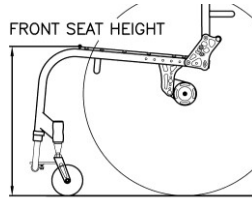

8. REAR SEAT HEIGHT

Measure from floor to top of seat sling at front bottom of backrest tube.

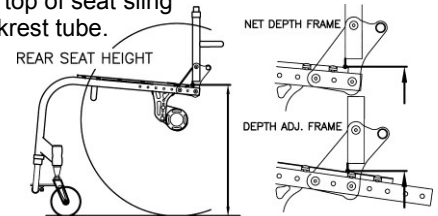

9. CENTER OF GRAVITY

Measure from center of back tube at the folding pivot to the center of the rear axle.

(If welding backrest is selected, Measure from center of back tube at the seat tube to the center of the rear axle.)

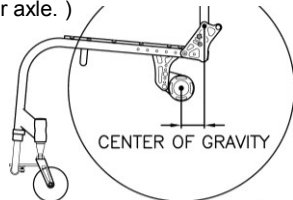

10. CAMBER ANGLE

Measure angle from wheel to vertical at floor.

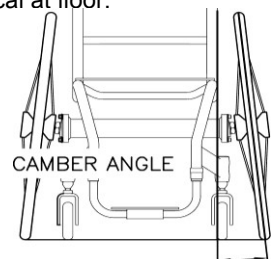

11. FRONT OF SEAT SLING TO FOOTREST

ADULT CHAIR

Measure from top of seat sling at front edge to top of foot plate at front edge.

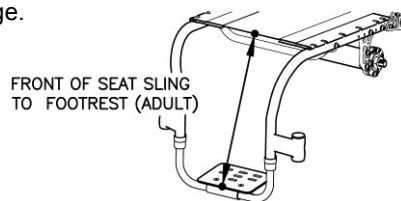

PEDIATRIC CHAIR

Measure vertical from top of seat sling at front edge to top of foot plate.



12. INSIDE WHEEL CLEARANCE

Measure from outside of seat back tube to inside of rear tire.

(If side guards are selected, measure from outside of side guards to inside of rear tire.)

