

DEALER			COLOURS INFORMATION For Office Use Only		
Dealer:			Order Date:		S/N:
Account:		P.O.#:	RTS		
Ordered By:			RTS:		Phone:
Address:			Email:		
City:		State:	Zip:		SHIP TO
Phone:		Fax:	Name:		Ship Via:
Email:			Address:		
Customer Name:			City:		State:
Customer Weight:			Phone:		Fax:

CHAIR INFORMATION	PRICE
RAZOR BLADE all terrain K0005	Base Wheel Chair Price K0005 \$ 2,400
Fixed FSH-RSH	Total Section A \$
Max. Capacity 250Lbs	Total Section B \$
Main Frame : ZK55 & ZK60 High Grade A7000 Series Aluminum	Total Section C \$
NOTE	Total Section D \$
Main Frame : Lifetime Warranty	Total Section E \$
*See warranty policy	Total Section F (Custom Parts Color) \$
	\$
	ORDER GRAND TOTAL \$

A FRAME COLORS & PARTS COLORS

FRAME COLORS		
Powder-Coated	<input type="checkbox"/> Gloss Black <input type="checkbox"/> Twilight Flake <input type="checkbox"/> Yellow <input type="checkbox"/> Magenta <input type="checkbox"/> Fire Engine Red <input type="checkbox"/> White <input type="checkbox"/> Candy Blue <input type="checkbox"/> Candy Purple <input type="checkbox"/> Candy Green <input type="checkbox"/> Candy Red <input type="checkbox"/> Candy Raspberry <input type="checkbox"/> Cobalt Blue <input type="checkbox"/> Matte Gray <input type="checkbox"/> Matte Purple <input type="checkbox"/> Matte Blue <input type="checkbox"/> Matte Green <input type="checkbox"/> Matte Black <input type="checkbox"/> Matte Red <input type="checkbox"/> Orange Sparkle <input type="checkbox"/> Mellon Yellow <input type="checkbox"/> Gun Smoke Silver <input type="checkbox"/> Pigeon Blue <input type="checkbox"/> Granny Sparkle Green <input type="checkbox"/> Sparkle Sky Blue <input type="checkbox"/> Vermilion <input type="checkbox"/> Reed Green <input type="checkbox"/> Blue Lilac	\$ STD
Special	<input type="checkbox"/> Polished	\$ 800

PARTS COLORS (Custom Parts Color Section,		
STD Color	Black Color (*Suspension Springs-Silver Color Only)	\$ STD
Custom Color Main Bolt on Parts One Color Package	<input type="checkbox"/> Powder-Coated () <input type="checkbox"/> Polished <input type="checkbox"/> 24 karat Gold	\$ 500 \$ 750 \$ CFP
Including: Backrest, Foot Plate, Footrest Rings, Backrest Brackets, Saddle Stops, Forks & Knurl Nuts, Caps, Front Suspension Springs, Axle Tube, Axle Clamps, Axle Plates, Axle Bases, Camber Discs ☆marked parts		

Total Section A \$

B FRAME MEASUREMENTS 1/2

Caster Size	D (Approximately)
3" Caster	1.5"
4" Caster	2.0"
5" Caster	3.0"
8" Air Caster	5.5"

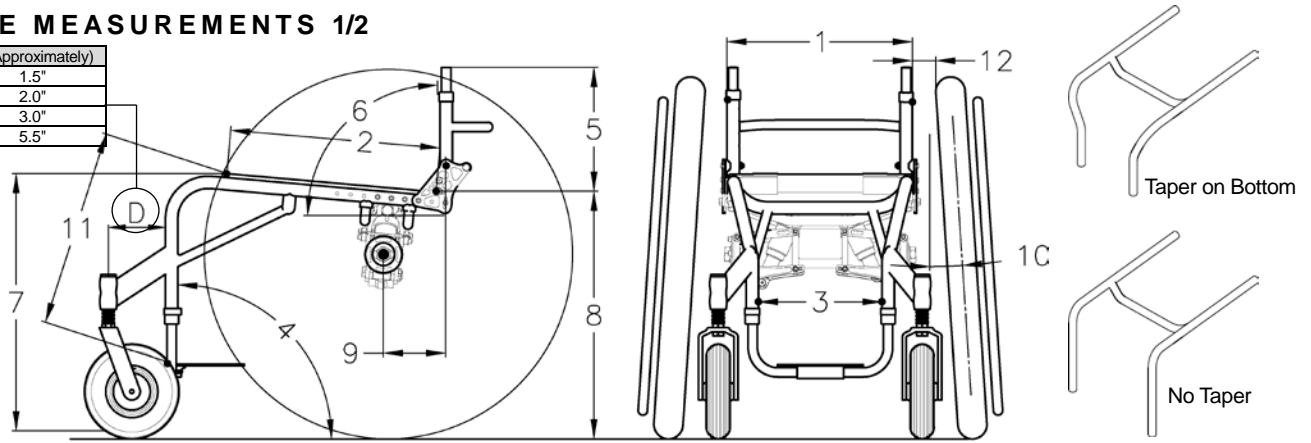

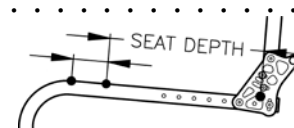
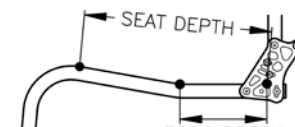
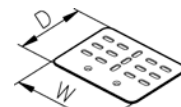
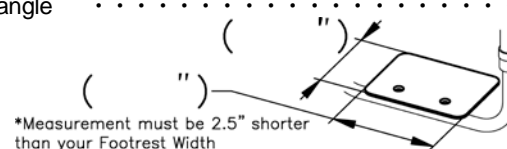
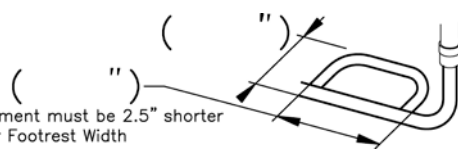
1. SEAT WIDTH	<input type="checkbox"/> 13" <input type="checkbox"/> 14" <input type="checkbox"/> 15" <input type="checkbox"/> 16" <input type="checkbox"/> 17" <input type="checkbox"/> 18" <input type="checkbox"/> 19"	\$	STD							
2. SEAT DEPTH * Only Choose One Option	<input type="checkbox"/> Net Seat Depth <input type="checkbox"/> 13" <input type="checkbox"/> 14" <input type="checkbox"/> 15" <input type="checkbox"/> 16" <input type="checkbox"/> 17" <input type="checkbox"/> 18" <input type="checkbox"/> 19" \$ STD <input type="checkbox"/> 20" E2203 \$ 300									
	<input type="checkbox"/> Depth Adj. Frame <input type="checkbox"/> Short Frame (16" Depth) Set at <input type="checkbox"/> 13" <input type="checkbox"/> 14" <input type="checkbox"/> 15" <input type="checkbox"/> 16" . . \$ STD <input type="checkbox"/> Long Frame (19" Depth) Set at <input type="checkbox"/> 16" <input type="checkbox"/> 17" <input type="checkbox"/> 18" <input type="checkbox"/> 19" . . \$ STD									
	<input type="checkbox"/> Positioning Frame Add (") \$ 150 									
	<input type="checkbox"/> Ergo Seat Tubing Depth (") \$ 200 *Measurement must be 2.5" longer than your Center of Gravity 									
3. FOOTREST WIDTH	<input type="checkbox"/> STD (Seat Width Minus 5") <input type="checkbox"/> Taper on Bottom Frame only \$ STD <input type="checkbox"/> Custom (") <input type="checkbox"/> Taper on Bottom Frame only \$ 150 <input type="checkbox"/> No Taper (Seat Width Minus 2") \$ STD									
	FOOT PLATE STYLE <input type="checkbox"/> Standard single loop with adjust. height & angle. STD Foot Plate \$ STD <input type="checkbox"/> Single Flip-Back-single loop (no riser avail) with adjust. height & angle. STD Foot Plate K0040 \$ 150									
	STD Foot Plate Size Chart <table border="1" data-bbox="649 1260 1120 1386"> <thead> <tr> <th>Your Footrest Width</th> <th>Foot Plate Size</th> </tr> </thead> <tbody> <tr> <td>8.5"-10.0"</td> <td>W6.5"xD5"</td> </tr> <tr> <td>10.5"-13.0"</td> <td>W8.5"xD6.5"</td> </tr> <tr> <td>13.5"-17.0"</td> <td>W11"xD6.5"</td> </tr> </tbody> </table> 	Your Footrest Width	Foot Plate Size	8.5"-10.0"	W6.5"xD5"	10.5"-13.0"	W8.5"xD6.5"	13.5"-17.0"	W11"xD6.5"	
Your Footrest Width	Foot Plate Size									
8.5"-10.0"	W6.5"xD5"									
10.5"-13.0"	W8.5"xD6.5"									
13.5"-17.0"	W11"xD6.5"									
CUSTOM FOOT PLATE	<input type="checkbox"/> Custom Foot Plate. with adjust. height & angle \$ 75 *Available Solid Plate Only 									
	<input type="checkbox"/> Custom Tubular Footrest \$ 250  <input type="checkbox"/> With ABS Foot Plate (\$65 up charge)									
4. FRAME ANGLE	<input type="checkbox"/> 75° <input type="checkbox"/> 80° <input type="checkbox"/> 85° <input type="checkbox"/> 90° to the ground \$ STD <input type="checkbox"/> Custom (°) to the ground \$ NCO									

B FRAME MEASUREMENTS 2/2

5. BACKREST HEIGHT 8" 9" 10" 11" 12" 13" 14" 15" 16" 17" 18" \$ STD
 * Rigidizer bar 3.25" deep std.

TYPE
 Locking mechan. with adjust. height & angle \$ STD
 Double Locking mechan. with adjust. height & angle \$ 25
 Omit Locking mechan. \$ NCO

CUSTOM
 Welded Backrest Angle Set at () to the ground *Non Folding Backrest . . . \$ 150
 Welded Side Guards *w / Welded Backrest only \$ 450

Custom Backrest \$ 150
 (ie: double rigidizer bars, custom depth, custom height, etc)

6. BACKREST ANGLE Set at ()° to the ground *STD 90° \$ STD

7. FRONT SEAT HEIGHT 17.0" 17.5" 18.0" 18.5" 19.0" \$ STD
19.5" 20.0" 20.5" 21.0"

Front Seat Height Ranges	Caster Wheel Size	Front Seat Height
	3" Caster	17.0" - 19.5"
	4" Caster	17.0" - 20.0"
	5" Caster	17.0" - 21.0"
	8" Air Caster	18.0" - 21.0"

8. REAR SEAT HEIGHT 14.5" 15.0" 15.5" *Not Available w / Air Ride System \$ STD
16.0" 16.5" 17.0" 17.5" 18.0" 18.5" 19.0" 19.5"
 *The rear seat heights are impacted by the size of your rear tire.

w/ Colours Air Ride System Rear Seat Height Option Black Color \$ 1,580
 *Including ;Fox Racing Shox 300 HP Pump

Powder-Coated () (\$380 up charge)
 Polished Aluminum (\$800 up charge)

STD Rear Seat Height Ranges		Rear Seat Height Ranges w/ Air Ride System		REAR SUSPENSION RATING
Rear Tire Size	Rear Seat Height	Rear Tire Size	Rear Seat Height	
24"x1"(540)	14.5"- 18.0"	24"x1"(540)	16.0"- 18.5"	<input type="checkbox"/> Set up 50psi (For 80 lbs-110 lbs weight)
24"x1 3/8"(540)	15.0"- 18.0"	24"x1 3/8"(540)	16.5"- 19.0"	<input type="checkbox"/> Set up 60psi (For 110 lbs-140 lbs weight)
25"x1"(559)	15.5"- 18.0"	25"x1"(559)	16.5"- 19.0"	<input type="checkbox"/> Set up 80psi (For 140 lbs-170 lbs weight)
24"x2"(540)	15.5"- 18.5"	24"x2"(540)	17.0"- 19.5"	<input type="checkbox"/> Set up 100psi (For 170 lbs-200 lbs weight)
26"x1"(590)	15.5"- 19.0"	26"x1"(590)	17.0"- 19.5"	<input type="checkbox"/> Set up 120psi (For 200 lbs-230 lbs weight)
25"x1.95"(559)	16.0"- 19.0"	25"x1.95"(559)	17.5"- 19.5"	<input type="checkbox"/> Set up 150psi (For 230 lbs-250 lbs weight)

*No Custom Modifications

9. CENTER OF GRAVITY 1.5" 2.0" 2.5" 3.0" 3.5" \$ STD
4.0" 4.5" 5.5" 6.0" *Not Available w / Net Seat Depth Frame

10. CAMBER ANGLE 2° 4° 6° \$ STD

11. FRONT OF SEAT SLING TO FRONT OF FOOTREST 15.0" 15.5" 16.0" 16.5" 17.0" 17.5" 18.0" 18.5" 19.0" 19.5" \$ STD
 *Not Available w / 19.0", 19.5", 20.0", 20.5", 21.0" Front Seat Height
 *Measurement must be 1.5" shorter than your Front Seat Height

HIGH MOUNT 11.0" 11.5" 12.0" 12.5" 13.0" 13.5" 14.0" 14.5" 15.0" 15.5" 16.0" . . . \$ 65
 With Risers or Clamps

12. INSIDE WHEEL CLEARANCE 3/4"* 1" 1 1/4" 1 1/2" 1 3/4" 2" \$ STD
 *3/4" Inside wheel clearance not available with 2 degree camber. (with the exception of Y-360 wheels)
 *3/4" Inside wheel clearance not available with Armrest *3/4" Inside wheel clearance not available with Bite Hub Locks

Sub Total Section B 1/2	\$
Sub Total Section B 2/2	\$
Total Section B	\$

C WHEELS, TIRES & CASTERS, FORKS 1/2

WHEELS

Standard Radial Spoke Wheel	<input type="checkbox"/> 24" (540) Only										\$ STD
Heat-Treated Wheel	<input type="checkbox"/> 24" (540)	<input type="checkbox"/> 25" (559)	<input type="checkbox"/> 26" (590)								\$ 250
Cross Knot Laced Spokes	<input type="checkbox"/> 24" (540)	<input type="checkbox"/> 25" (559)	<input type="checkbox"/> 26" (590)								\$ 250
Twister Super Strength wheel	<input type="checkbox"/> 24" (540)	<input type="checkbox"/> 25" (559)	<input type="checkbox"/> 26" (590)								\$ 300
SUN Fusion 16 Wheel	<input type="checkbox"/> 24" (540)	<input type="checkbox"/> 25" (559)									\$ 410
16 Black Spokes	Hub Color	<input type="checkbox"/> Black	<input type="checkbox"/> Silver								
Y-360 Billet Wheels	<input type="checkbox"/> 24" (540)	<input type="checkbox"/> 25" (559)									\$ 999
*Max. Capacity 220Lbs *Camber 0- 2" max *Not for Sports or Rugged use	Style	<input type="checkbox"/> Saw Blade	<input type="checkbox"/> Hearts(25"only)	<input type="checkbox"/> T-Style(25"only)							
Y-360 Billet Wheels MOD Style	<input type="checkbox"/> 25" (559) Only										\$ 1,499
*Max. Capacity 220Lbs *Camber 0- 2" max *Not for Sports or Rugged use	Style	<input type="checkbox"/> Tribal Sun	<input type="checkbox"/> Girls	<input type="checkbox"/> Eagle	<input type="checkbox"/> Holy Cross	<input type="checkbox"/> Hono					
	Specify Powder Coat Color for Insert Only ()	*Choose from Frame Colors									
Extra Options for Y-360	<input type="checkbox"/> Spinners Clover (\$650 up charge)										
	<input type="checkbox"/> Powder-Coated Spokes Only ()	*Choose from Frame Colors (\$150 up charge)									
X-Core (3 Spokes comp)	<input type="checkbox"/> 25" (559) Only										\$ 743
*Camber 0- 2" max *Not available with D's Lock *Not available with long tabs	Wheel Color	<input type="checkbox"/> Black									
Spinergy Spox 18 Spokes	<input type="checkbox"/> 24" (540)	<input type="checkbox"/> 25" (559)	<input type="checkbox"/> 26" (590)								\$ 695
	Spoke Color	<input type="checkbox"/> Black	<input type="checkbox"/> Red	<input type="checkbox"/> Yellow	<input type="checkbox"/> Blue	<input type="checkbox"/> White					
		With Silver Hub	With Black Hub	With Black Hub	With Black Hub	With Black Hub					
	<input type="checkbox"/> Custom Color Spoke Pattern										
				Left Wheel	Right Wheel						\$ 795
	Spokes	Inside									
	Color	Outside									
	Hub Color		<input type="checkbox"/> Black/ <input type="checkbox"/> Silver	<input type="checkbox"/> Black/ <input type="checkbox"/> Silver							
Spinergy LX 12 Spokes	<input type="checkbox"/> 24" (540)	<input type="checkbox"/> 25" (559)	<input type="checkbox"/> 26" (590)								\$ 895
	Spoke Color	<input type="checkbox"/> Black	<input type="checkbox"/> Red	<input type="checkbox"/> Yellow	<input type="checkbox"/> Blue						
		With Silver Hub	With Black Hub	With Black Hub	With Black Hub						
	<input type="checkbox"/> Custom Color Spoke Pattern										
				Left Wheel	Right Wheel						\$ 995
	Spokes	Inside									
	Color	Outside									
	Hub Color		<input type="checkbox"/> Black/ <input type="checkbox"/> Silver	<input type="checkbox"/> Black/ <input type="checkbox"/> Silver							
Topolino Cabon Core WX2.5 Wheels	Black Spokes Only	<input type="checkbox"/> 24" (540)	<input type="checkbox"/> 25" (559)								\$ 910
*Not available with D's Lock	Nipples Color	<input type="checkbox"/> Red	<input type="checkbox"/> Yellow								

HANDRIMS

Type	<input type="checkbox"/> Standard For 24", 25" or 26" Wheel Anodized Black (*Not available with Pro Wheels)	\$ STD
	<input type="checkbox"/> Vinyl Coated For 24", 25", 26" Wheel (*Not available with Pro Wheels)	\$ 142
	<input type="checkbox"/> Natural Fit For 24", 25" Wheel	
	<input type="checkbox"/> Standard Grip (Not available with short tabs. Not available with Y-360 Billet Wheels, X-Core, Topolino Wheels, Pro Wheels, Mag Wheels)	\$ 295
	<input type="checkbox"/> Super Grip (Not available with short tabs. Not available with Y-360 Billet Wheels, X-Core, Topolino Wheels, Pro Wheels, Mag Wheels)	\$ 340
	<input type="checkbox"/> Without Thumb Grip (Not available with Y-360 Billet Wheels, Not available with Pro Wheels, Mag Wheels)	\$ 270
	<input type="checkbox"/> Natural Fit (LT) For 24", 25" Wheel	
	<input type="checkbox"/> Standard Grip (Not available with short tabs. Not available with Y-360 Billet Wheels, X-Core, Topolino Wheels, Pro Wheels, Mag Wheels)	\$ 325
	<input type="checkbox"/> Super Grip (Not available with short tabs. Not available with Y-360 Billet Wheels, X-Core, Topolino Wheels, Pro Wheels, Mag Wheels)	\$ 370
	<input type="checkbox"/> Without Thumb Grip (Not available with Y-360 Billet Wheels, Not available with Pro Wheels, Mag Wheels)	\$ 300
	<input type="checkbox"/> The Surge Handrims * Not available with Y-360 Billet Wheels * w / X-Core Wheels required Installation fee (\$30) flat fee	\$ 315
	<input type="checkbox"/> The Surge Handrims (LT) * Not available with Y-360 Billet Wheels * w / X-Core Wheels required Installation fee (\$30) flat fee	\$ 340
	<input type="checkbox"/> Spinergy Flex Rim Available only on 24" and 25" Spinergy LX.	\$ 495
	<input type="checkbox"/> Projections Handrims *Not available with Y-360 Billet Wheels, X-Core, Topolino Wheels, Pro Wheels, Mag Wheels)	\$ E0967 CFP
	*Call For Availability	

TAB LENGTH	<input type="checkbox"/> Long Tab (STD inside clearance 3/4") * Not available with X-Core Wheels	\$ STD
	<input type="checkbox"/> Short Tab (Inside clearance 1/2") *Not available with Ultra Grip and Natural Fit Handrim with thumb grip	\$ STD
	<input type="checkbox"/> Short Tab (Set closest to wheel cut off excess) * Not available with Y-360 wheel, Pro Wheels, X-Core, Pro Wheels	\$ 15

C WHEELS, TIRES & CASTERS, FORKS 2/2

TIRES

<input type="checkbox"/> High Pressure Tire □24"x1", □25"x1" or □26"x1" Gray Tire with black wall Only	E2211/E2212	\$ STD
<input type="checkbox"/> High Pressure Tire □24"x1", □25"x1" or □26"x1" □Blue □Red	E2211/E2212	\$ 65
<input type="checkbox"/> Low Pressure Tire □24"x1-3/8" or □26"x1-3/8" Gray Only	E2211/E2212	\$ STD
<input type="checkbox"/> E2211Schwalbe Marathon Plus High Pressure Tire □24"x1", □25"x1" or □26"x1" Black Only	E2211/E2212	\$ 99
<input type="checkbox"/> Solid Tire □24"x1", □25"x1" or □26"x1" □Dark Gray □Black(\$30up charge)	E2218	\$ 135
<input type="checkbox"/> E2211 Moderate V-Track Knobby Tire 24"x1-3/8" (37-540) Gray Only	E2211/E2212	\$ 117
<input type="checkbox"/> E2211 Aggressive Knobby Tire 24"x 2" (50-540) Gray Only	E2211/E2212	\$ 117
<input type="checkbox"/> E2211 Aggressive Knobby Tire 26"x 1.95" (50-559) Black Only	E2211/E2212	\$ 117
<input type="checkbox"/> E2213 Flat-Free Inserts For 24"x1-3/8" Tires Only	E2211/E2213	\$ 117

CASTERS

SIZE	TIRE WIDTH	HUB COLOR	TIRE COLOR	DESCRIPTION	
<input type="checkbox"/> 3"	1"	Black Hub	Black Tire Only	Polyeurathane	\$ STD
<input type="checkbox"/> 3"	1"	Plastic Black Hub	Clear Tire Only	Lighted, Polyeurathane	\$ 65
<input type="checkbox"/> 3"	1"	Red Hub	Red Tire Only	Polyeurathane	\$ STD
<input type="checkbox"/> 3"	1"	Black Hub	Clear Tire Only	Polyeurathane	\$ STD
<input type="checkbox"/> 3"	1"	Aluminum Silver Hub	Black Tire Only	Made By Frog Legs	\$ 165
<input type="checkbox"/> 3"	1"	Aluminum Black Hub	Black Tire Only	Made By Frog Legs	\$ 165
<input type="checkbox"/> 3"	1.5"	Aluminum Silver Hub	Black Tire Only	Soft Roll Made By Frog Legs	\$ 165
<input type="checkbox"/> 3"	1.5"	Aluminum Black Hub	Black Tire Only	Soft Roll Made By Frog Legs	\$ 165
<input type="checkbox"/> 4"	1"	Plastic Black Hub	Black Tire Only		\$ STD
<input type="checkbox"/> 4"	1"	Plastic Black Hub	Clear Only	Lighted, Polyeurathane	\$ 65
<input type="checkbox"/> 4"	1"	Aluminum Silver Hub	Black Tire Only	Made By Frog Legs	\$ 165
<input type="checkbox"/> 4"	1"	Aluminum Black Hub	Black Tire Only	Made By Frog Legs	\$ 165
<input type="checkbox"/> 4"	1.5"	Composite Black Hub	Tire □Black □Blue □Red	Soft Roll Made By Frog Legs	\$ 135
<input type="checkbox"/> 4"	1.5"	Aluminum Silver Hub	Tire □Black □Blue □Red	Soft Roll Made By Frog Legs	\$ 165
<input type="checkbox"/> 4"	1.5"	Aluminum Black Hub	Black Tire Only	Soft Roll Made By Frog Legs	\$ 165
<input type="checkbox"/> 5"	1"	Composite Black Hub	Black Tire Only		\$ STD
<input type="checkbox"/> 5"	1"	Plastic Black Hub	Clear Tire Only	Lighted, Polyeurathane	\$ 65
<input type="checkbox"/> 5"	1"	Aluminum Silver Hub	Black Tire Only	Made By Frog Legs	\$ 165
<input type="checkbox"/> 5"	1"	Aluminum Black Hub	Black Tire Only	Made By Frog Legs	\$ 165
<input type="checkbox"/> 5"	1.5"	Aluminum Silver Hub	Tire □Black □Blue □Red	Soft Roll Made By Frog Legs	\$ 165
<input type="checkbox"/> 5"	1.5"	Aluminum Black Hub	Black Tire Only	Soft Roll Made By Frog Legs	\$ 165
<input type="checkbox"/> 8"	1.5"	Composite Black Hub	Black Tire Only	8" Air Caster w/Monster Fork	\$ 200

FORKS

<input type="checkbox"/> STD Aluminum Forks With Suspension Springs Black Only	E1015	\$ STD
Extra Options for Aluminum Forks □ Without Suspension Springs		\$ NCO
□With Quick Release Axles	K0073	\$ 107
<input type="checkbox"/> Frog Leg Suspension Forks Std 1" Wide (For 3", 4" x 1" width Caster and 5" STD Caster, 5" lighted Caster) (Not available with Quick Release Axles)	E1015	\$ 575
Color □Anodized Black □Anodized Silver		
*Not Available w / 8x1.5" Casters		
<input type="checkbox"/> Frog Leg Suspension Forks 1.5" Wide (For 3", 4" x 1.5" width Caster and 5" x 1"& 5" x 1.5" Casters) (Not available with Quick Release Axles)	E1015	\$ 575
Color □Anodized Black □Anodized Silver		
*Not Available w / 8x1.5" Casters		

Sub Total Section C 1/2 \$
 Sub Total Section C 2/2 \$
Total Section C \$

D COMPONENTS

WHEEL LOCKS

<input type="checkbox"/> Push to Lock / Anodized Black Only	\$ STD
<input type="checkbox"/> NEW Compact Push to Lock / Anodized Black Only <input type="checkbox"/> w/ 2" Extension Handle (\$65up)	\$ 110
<input type="checkbox"/> NEW Compact Scissor Lock / Anodized Black Only	\$ 110

PUSH HANDLES *If you are ordering push handles, You must select the backrest locking mechanism.

<input type="checkbox"/> Integrated w/Fixed Backrest Height / Anodized Black Only	\$ STD
<input type="checkbox"/> Bolt-on / Anodized Black Only Specify Height from floor -(")	\$ 142
<input type="checkbox"/> Bolt-on w/Quick Release / Anodized Black Only Specify Height from floor -(")	\$ 190
<input type="checkbox"/> NEW Height Adj. / Anodized Black Only Specify Maximum height from floor -(")	\$ 295

NEW ARM RESTS Anodized Black Only,

<input type="checkbox"/> Fixed Tubular Armrest Adj. Angle and Height Height from seat sling Set at : <input type="checkbox"/> 8" <input type="checkbox"/> 9" <input type="checkbox"/> 10" <input type="checkbox"/> 11" <input type="checkbox"/> 12" E0973	\$ 250
<input type="checkbox"/> Swing Away Tubular Armrest Adj. Angle and Height Height from seat sling Set at : <input type="checkbox"/> 8" <input type="checkbox"/> 9" <input type="checkbox"/> 10" <input type="checkbox"/> 11" <input type="checkbox"/> 12" E0973	\$ 250
<input type="checkbox"/> Flip-Up Armrest <input type="checkbox"/> w/Fixed Tubular Armrest Height from seat sling Set at : <input type="checkbox"/> 8" <input type="checkbox"/> 9" <input type="checkbox"/> 10" <input type="checkbox"/> 11" <input type="checkbox"/> 12" E0973	\$ 250
Adj. Angle <input type="checkbox"/> w/ Swing Away Tubular Armrest Height from seat sling Set at : <input type="checkbox"/> 8" <input type="checkbox"/> 9" <input type="checkbox"/> 10" <input type="checkbox"/> 11" <input type="checkbox"/> 12" E0973	\$ 250

Custom Length & Height (\$150 up charge)
*Specify Height & Length →

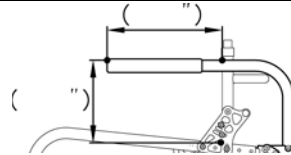

ANTI-TIPPERS

<input type="checkbox"/> Anti-Tippers (pair) w/ Quick Release / Anodized Black Only	E0971 \$ 112
-----------------------------------------------------------------------------------------------	--------------

SIDE GUARDS

<input type="checkbox"/> Rigid Side Guards - Black ABS <input type="checkbox"/> Non-Removable <input type="checkbox"/> Removable <input type="checkbox"/> Removable w/Hole (\$10 up charge) Size: <input type="checkbox"/> STD <input type="checkbox"/> Medium <input type="checkbox"/> Cut to Wheel (\$98 up charge) Measurement	\$ 142
--------------------------------------------------------------------------------------------------------------------------------------------------------------------------------------------------------------------------------------------------------------------------------------------------------------------------------------	--------

<input type="checkbox"/> Rigid Side Guards - Aluminum <input type="checkbox"/> Non-Removable <input type="checkbox"/> Removable Size: <input type="checkbox"/> Medium Only <input type="checkbox"/> Cut to Wheel (\$98 up charge) Measurement Color <input type="checkbox"/> Black (STD) <input type="checkbox"/> Pol. Aluminum (STD) <input type="checkbox"/> Powder Coated () (\$50 up charge) <input type="checkbox"/> Gold Plate (+CFP)	\$ 197
----------------------------------------------------------------------------------------------------------------------------------------------------------------------------------------------------------------------------------------------------------------------------------------------------------------------------------------------------------------------------------------------------------------------------------------------------------	--------

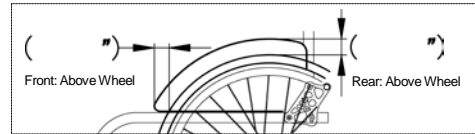
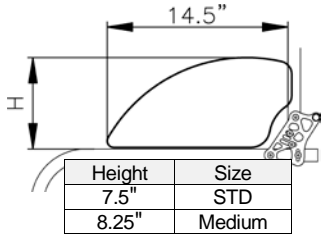

<input type="checkbox"/> PRO-TEX Fender Guards / (Black ABS -Only) <input type="checkbox"/> Cut to Fit Specs <input type="checkbox"/> Do Not Install	\$ 175
<input type="checkbox"/> Fabric Clothing Guards Black Nylon w/Velcro	\$ 78

SEAT CUSHION -*Please see section E for other cushion choices.-

<input type="checkbox"/> Foam Cushion w/Nylon Black Cover Thickness <input type="checkbox"/> 1" <input type="checkbox"/> 2" <input type="checkbox"/> 3" <input type="checkbox"/> 4"	\$ 78
<input type="checkbox"/> Custom Cushion Cover (Std. Foam Cushion Only) -Select Fabric () (\$90 up charge)	

MISCELLANEOUS

<input type="checkbox"/> Frame Protectors / Black Leather/Zipper Type	\$ 78
<input type="checkbox"/> K0065 Spoke Protectors / Black Only <input type="checkbox"/> 24" <input type="checkbox"/> 25" <input type="checkbox"/> 26"	K0065 \$ 107
<input type="checkbox"/> E0978 Seat Belt w/Auto Buckle (BP) 1.5" Black Belt Only	E0978 \$ 69
<input type="checkbox"/> Tie Down Brackets 4pcs.	\$ 210

UPHOLSTERY CHOICE & COLOR *Positioning Back Available. Please see Section E

<input type="checkbox"/> Standard Adjustable Ht Backrest Black Only	\$ STD
<input type="checkbox"/> Adjustable Tension Backrest Black Only (*Not available with 8" Backrest Height)	\$ 135
Custom Options <input type="checkbox"/> Fabrics for Fun <input type="checkbox"/> 001 <input type="checkbox"/> 002 <input type="checkbox"/> 003 <input type="checkbox"/> 004 <input type="checkbox"/> 006 <input type="checkbox"/> 010 <input type="checkbox"/> 011 . . . (\$95 up charge) For Std. or Adj. Style <input type="checkbox"/> 014 <input type="checkbox"/> 015 <input type="checkbox"/> 016 <input type="checkbox"/> 017 <input type="checkbox"/> 018 <input type="checkbox"/> 020 <input type="checkbox"/> 021 <input type="checkbox"/> 022 <input type="checkbox"/> 023 <input type="checkbox"/> 024 <input type="checkbox"/> 025 <input type="checkbox"/> 026 <input type="checkbox"/> 027 <input type="checkbox"/> 028 <input type="checkbox"/> Backrest Leather Trim (outside panels) (\$77 up charge)	
<input type="checkbox"/> Calf Strap <input type="checkbox"/> Black <input type="checkbox"/> Matching Fabric (\$55 up charge) -Select Fabric()	K0038 \$ 24
<input type="checkbox"/> Matching Fabric on Padded Side Guards -Select Fabric ()	\$ 210

Total Section D \$

E CHAIR OPTIONS 1/2

SEAT CUSHION

SUPRACOR® WHEELCHAIR CUSHIONS

Stimulite® Contoured Cushion *Black Upholstery only	<input type="checkbox"/> W14"xD16" (CD1416)	E2603	\$ 525
	<input type="checkbox"/> W16"xD16" (CD1616)	E2603	\$ 525
	<input type="checkbox"/> W16"xD18" (CD1618)	E2603	\$ 525
	<input type="checkbox"/> W18"xD16" (CD1816)	E2603	\$ 525
	<input type="checkbox"/> W18"xD18" (CD1818)	E2603	\$ 525
	<input type="checkbox"/> W18"xD20" (CD1820)	E2603	\$ 540
	<input type="checkbox"/> W20"xD16" (CD2016)	E2603	\$ 540
	<input type="checkbox"/> W20"xD18" (CD2018)	E2603	\$ 540
	<input type="checkbox"/> W20"xD20" (CD2020)	E2603	\$ 555
			<input type="checkbox"/> Extra Sensitive (\$30 up charge) <input type="checkbox"/> Sling Style Bottom (\$45 up charge) <input type="checkbox"/> Custom Size W(") x D(") (-\$ CFP)

Stimulite® Slimline Cushion *Black Upholstery only	<input type="checkbox"/> W14"xD16" (SM1416)	E2603	\$ 495
	<input type="checkbox"/> W16"xD16" (SM1616)	E2603	\$ 495
	<input type="checkbox"/> W16"xD18" (SM1618)	E2603	\$ 495
	<input type="checkbox"/> W18"xD18" (SM1818)	E2603	\$ 495
	<input type="checkbox"/> W18"xD20" (SM1820)	E2603	\$ 495
	<input type="checkbox"/> W20"xD16" (SM2016)	E2603	\$ 510
	<input type="checkbox"/> W20"xD18" (SM2018)	E2603	\$ 510
	<input type="checkbox"/> W20"xD20" (SM2020)	E2603	\$ 510
			<input type="checkbox"/> Extra Sensitive (\$30 up charge) <input type="checkbox"/> Sling Style Bottom (\$45 up charge) <input type="checkbox"/> Custom Size W(") x D(") (-\$ CFP)

Stimulite® Corbee Pediatric *Black Upholstery only	<input type="checkbox"/> W10"xD10" (PD1010)	E2603	\$ 450
	<input type="checkbox"/> W12"xD12" (PD1212)	E2603	\$ 450
	<input type="checkbox"/> W14"xD14" (PD1414)	E2603	\$ 450
		<input type="checkbox"/> Extra Sensitive (\$30 up charge) <input type="checkbox"/> Sling Style Bottom (\$45 up charge) <input type="checkbox"/> Custom Size W(") x D(") (-\$ CFP)	

ROHO WHEELCHAIR CUSHIONS

<input type="checkbox"/> 4" HIGH PROFILE® QUADTRO SELECT® CUSHION *Black Upholstery		E2622-2623	\$ 525
Choose Size	<input type="checkbox"/> W12"xD12" <input type="checkbox"/> W12"xD13" <input type="checkbox"/> W13"xD13" <input type="checkbox"/> W13"xD15" <input type="checkbox"/> W13"xD16" <input type="checkbox"/> W15"xD13" <input type="checkbox"/> W15"xD15" <input type="checkbox"/> W15"xD16" <input type="checkbox"/> W15"xD18" <input type="checkbox"/> W16"xD15" <input type="checkbox"/> W16"xD16" <input type="checkbox"/> W16"xD18" <input type="checkbox"/> W16"xD20" <input type="checkbox"/> W18"xD15" <input type="checkbox"/> W18"xD16" <input type="checkbox"/> W18"xD18" <input type="checkbox"/> W18"xD20" <input type="checkbox"/> W18"xD22" <input type="checkbox"/> W20"xD16" <input type="checkbox"/> W20"xD18" <input type="checkbox"/> W20"xD20" <input type="checkbox"/> W20"xD22" <input type="checkbox"/> W22"xD18" <input type="checkbox"/> W22"xD20" <input type="checkbox"/> W22"xD22" <input type="checkbox"/> Custom Size W(") x D(") (+\$85)		

<input type="checkbox"/> 3" MID PROFILE® QUADTRO SELECT® CUSHION *Black Upholstery only		E2622-2623	\$ 525
Choose Size	<input type="checkbox"/> W15"xD15" <input type="checkbox"/> W15"xD16" <input type="checkbox"/> W16"xD16" <input type="checkbox"/> W16"xD18" <input type="checkbox"/> W18"xD16" <input type="checkbox"/> W18"xD18" <input type="checkbox"/> Custom Size W(") x D(") (+\$85)		

<input type="checkbox"/> 2" LOW PROFILE® QUADTRO SELECT® CUSHION *Black Upholstery only		E2622-2623	\$ 525
Choose Size	<input type="checkbox"/> W12"xD12" <input type="checkbox"/> W12"xD13" <input type="checkbox"/> W13"xD13" <input type="checkbox"/> W13"xD15" <input type="checkbox"/> W13"xD16" <input type="checkbox"/> W15"xD13" <input type="checkbox"/> W15"xD15" <input type="checkbox"/> W15"xD16" <input type="checkbox"/> W15"xD18" <input type="checkbox"/> W16"xD15" <input type="checkbox"/> W16"xD16" <input type="checkbox"/> W16"xD18" <input type="checkbox"/> W16"xD20" <input type="checkbox"/> W18"xD15" <input type="checkbox"/> W18"xD16" <input type="checkbox"/> W18"xD18" <input type="checkbox"/> W18"xD20" <input type="checkbox"/> W20"xD16" <input type="checkbox"/> W20"xD18" <input type="checkbox"/> W20"xD20" <input type="checkbox"/> Custom Size W(") x D(") (+\$85)		

<input type="checkbox"/> 2" NEXUS SPIRIT® CUSHION *Black Upholstery only		E2622	\$ 525
Choose Size	<input type="checkbox"/> W14"xD14" <input type="checkbox"/> W14"xD16" <input type="checkbox"/> W15"xD15" <input type="checkbox"/> W16"xD16" <input type="checkbox"/> W16"xD18" <input type="checkbox"/> W17"xD17" <input type="checkbox"/> W18"xD16" * Custom Size Not Available		

STAR CUSHIONS

Galaxy Cushion *Black Upholstery only		E2624	\$ 498
<input type="checkbox"/> W14"xD14" (GXY 1414-2) <input type="checkbox"/> W14"xD16" (GXY 1416-2) <input type="checkbox"/> W16"xD14" (GXY 1614-2) <input type="checkbox"/> W16"xD16" (GXY 1616-2) <input type="checkbox"/> W16"xD18" (GXY 1618-2) <input type="checkbox"/> W18"xD16" (GXY 1816-2) ⇒ <input type="checkbox"/> W18"xD18" (GXY 1818-2) <input type="checkbox"/> W18"xD20" (GXY 1820-2) <input type="checkbox"/> W20"xD16" (GXY 2016-2) <input type="checkbox"/> W20"xD18" (GXY 2018-2)	Choose Zoning Options <input type="checkbox"/> Standard - Dual Valve <input type="checkbox"/> Dual Valve - Front to Back <input type="checkbox"/> Four Valve <input type="checkbox"/> Simple - Single Valve <input type="checkbox"/> Four Valve - Enhanced <input type="checkbox"/> Four Valve - Front to Back		

THE CURVE CUSHION *Black Upholstery only						\$ 133
<input type="checkbox"/> W10"xD10"	<input type="checkbox"/> W10"xD11"	<input type="checkbox"/> W10"xD11"	<input type="checkbox"/> W10"xD12"	<input type="checkbox"/> W11"xD12"	<input type="checkbox"/> W12"xD12"	
<input type="checkbox"/> W12"xD13"	<input type="checkbox"/> W12"xD14"	<input type="checkbox"/> W13"xD11"	<input type="checkbox"/> W13"xD12"	<input type="checkbox"/> W13"xD13"	<input type="checkbox"/> W13"xD14"	
<input type="checkbox"/> W14"xD14"	<input type="checkbox"/> W14"xD15"	<input type="checkbox"/> W14"xD16"	<input type="checkbox"/> W15"xD14"	<input type="checkbox"/> W15"xD15"	<input type="checkbox"/> W15"xD16"	
<input type="checkbox"/> W16"xD14"	<input type="checkbox"/> W16"xD15"	<input type="checkbox"/> W16"xD16"	<input type="checkbox"/> W16"xD17"	<input type="checkbox"/> W16"xD18"	<input type="checkbox"/> W17"xD16"	
<input type="checkbox"/> W17"xD17"	<input type="checkbox"/> W17"xD18"	<input type="checkbox"/> W18"xD16"	<input type="checkbox"/> W18"xD17"	<input type="checkbox"/> W18"xD18"		

NOTE

E CHAIR OPTIONS 2/2

POSITIONING BACK

***Note : Actual height of the backrest will increase 2" or more.**

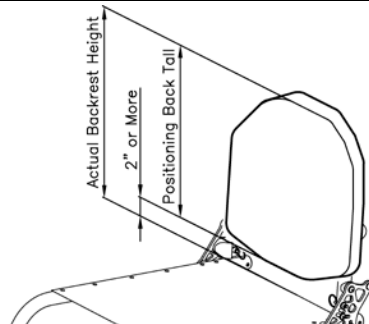

ADI CARBON BACKREST (Support Contour-ACTIVE 2.5") *Not Available with Welded Side Guards

Mounting Hardware: 2 Point Pro Quick Release

Height	<input type="checkbox"/> LOW (10" Tall) *Backrest Height requires 12" or more *Available 13"-19" width	Width ()	E2613	\$ 745
	<input type="checkbox"/> Medium (13" Tall) *Backrest Height requires 15" or more *Available 13"-19" width	Width ()	E2613	\$ 815
	<input type="checkbox"/> Standard (16" Tall) *Backrest Height requires 18" or more *Available 13"-19" width	Width ()	E2613	\$ 880
	<input type="checkbox"/> Custom Size (" Tall) x (" width)		E2613	\$ CFP

ADI ALUMINUM BACKREST (Support Contour-ACTIVE 2.5") *Not Available with Welded Side Guards

Mounting Hardware: 2 Point Pro Quick Release

Height	<input type="checkbox"/> LOW (10" Tall) *Backrest Height requires 12" or more *Available 10"-20" width	Width ()	E2613	\$ 610
	<input type="checkbox"/> Medium (13" Tall) *Backrest Height requires 15" or more *Available 12"-20" width	Width ()	E2613	\$ 625
	<input type="checkbox"/> Standard (16" Tall) *Backrest Height requires 18" or more *Available 14"-20" width	Width ()	E2613	\$ 640
	<input type="checkbox"/> Tall (18" Tall) *Backrest Height requires 20" or more *Available 16"-20" width	Width ()	E2613	\$ 655
	<input type="checkbox"/> X-Tall (20" Tall) *Backrest Height requires 22" or more *Available 16"-20" width	Width ()	E2613	\$ 670
	<input type="checkbox"/> Custom Size (" Tall) x (" width)		E2613	\$ CFP

ADI ALUMINUM BACKREST (Support Contour-DEEP 4") *Not Available with Welded Side Guards *Not Available with Lateral Supports

Mounting Hardware: 2 Point Pro Quick Release

Height	<input type="checkbox"/> LOW (10" Tall) *Backrest Height requires 12" or more *Available 10"-20" width	Width ()	E2615	\$ 710
	<input type="checkbox"/> Medium (13" Tall) *Backrest Height requires 15" or more *Available 12"-20" width	Width ()	E2615	\$ 725
	<input type="checkbox"/> Standard (16" Tall) *Backrest Height requires 18" or more *Available 14"-20" width	Width ()	E2615	\$ 740
	<input type="checkbox"/> Tall (18" Tall) *Backrest Height requires 20" or more *Available 16"-20" width	Width ()	E2615	\$ 755
	<input type="checkbox"/> X-Tall (20" Tall) *Backrest Height requires 22" or more *Available 16"-20" width	Width ()	E2615	\$ 770
	<input type="checkbox"/> Custom Size (" Tall) x (" width)		E2615	\$ CFP

ADI LATERAL SUPPORTS (Lateral Supports are compatible with only active 2.5" ADI positioning back.)

<input type="checkbox"/> Stationary Pad	Pad Size <input type="checkbox"/> Small (3" H x 3" D) <input type="checkbox"/> Medium(3" H x 4" D) <input type="checkbox"/> Large(4.5" H x 4.5" D) <input type="checkbox"/> Large(4" H x 6" D)		
	<input type="checkbox"/> Pair		\$ 320
	<input type="checkbox"/> Left side only or <input type="checkbox"/> Right side only		\$ 160
<input type="checkbox"/> Swing-Out	Pad Size <input type="checkbox"/> Small (3" H x 3" D) <input type="checkbox"/> Medium(3" H x 4" D) <input type="checkbox"/> Large(4.5" H x 4.5" D) <input type="checkbox"/> Large(4" H x 6" D)		
	<input type="checkbox"/> Pair		\$ 520
	<input type="checkbox"/> Left side only or <input type="checkbox"/> Right side only		\$ 260

OTHER

<input type="checkbox"/> ADI Transfer Board	<input type="checkbox"/> 21" (ADV21) <input type="checkbox"/> 24" (ADV24) <input type="checkbox"/> 29"		\$ 62
<input type="checkbox"/> ADI Push and Transfer Gloves	Leather (one size fits)		\$ 60
<input type="checkbox"/> ADI Carbon Solid Seat	(Wide: 18" Max, Depth: 20") *Colours Side Guards Not Available with ADI Carbon Solid Seat		\$ 625
	With / <input type="checkbox"/> ADI Folding Carbon Side Guard		\$ 400
	With / <input type="checkbox"/> ADI Fixed Carbon Side Guard		\$ 375

VARILITE® Seating Systems Available

Please visit for all options. www.varilite.com CFP

NOTE

Sub Total Section E 1/2 \$

Sub Total Section E 2/2 \$

Total Section E \$

F SPECIAL PARTS COLORS (Please allow an additional 1-2 weeks delivery)

PARTS COLORS

Powder-Coated	Gloss Black	Twilight Flake	Yellow	Magenta	Fire Engine Red	White
	Candy Blue	Candy Purple	Candy Green	Candy Red	Candy Raspberry	Cobalt Blue
	Matte Gray	Matte Purple	Matte Blue	Matte Green	Matte Black	Matte Red
			Orange Sparkle	Mellon Yellow	Gun Smoke Silver	Pigeon Blue
	Granny Sparkle Green	Sparkle Sky Blue	Vermilion	Reed Green	Blue Lilac	

Special Colors Polished Aluminum
 24 karat Gold Plated *Please allow an additional 4 weeks delivery

Please Choose the Color for each Part

*Parts not selected will be black color. (Suspension Spring: Silver Color)

*Minimum 3 parts selected per order.

*PC=Powder-Coated

Saddle Stops

<input type="checkbox"/> PC ()	\$40
<input type="checkbox"/> Polished	\$115
<input type="checkbox"/> Gold Plated	\$CFP

Backrest

<input type="checkbox"/> PC ()	\$125
<input type="checkbox"/> Polished	\$225
<input type="checkbox"/> Gold Plated	\$CFP

Backrest Brackets

<input type="checkbox"/> PC ()	\$90
<input type="checkbox"/> Polished	\$115
<input type="checkbox"/> Gold Plated	\$CFP

Foot Plate

<input type="checkbox"/> PC ()	\$45
<input type="checkbox"/> Polished	\$90
<input type="checkbox"/> Gold Plated	\$CFP

Footrest Rings

<input type="checkbox"/> PC ()	\$20
<input type="checkbox"/> Polished	\$40
<input type="checkbox"/> Gold Plated	\$CFP

Foot Plate Clamps

<input type="checkbox"/> PC ()	\$50
<input type="checkbox"/> Polished	\$75
<input type="checkbox"/> Gold Plated	\$CFP

Cap

<input type="checkbox"/> PC ()	\$20
<input type="checkbox"/> Polished	N/A
<input type="checkbox"/> Gold Plated	N/A

Front Springs

<input type="checkbox"/> PC ()	\$20
<input type="checkbox"/> Polished	N/A
<input type="checkbox"/> Gold Plated	N/A

Forks & Knurl Nuts

<input type="checkbox"/> PC ()	\$65
<input type="checkbox"/> Polished	\$90
<input type="checkbox"/> Gold Plated	\$CFP

Axle Tube

<input type="checkbox"/> PC ()	\$50
<input type="checkbox"/> Polished	\$75
<input type="checkbox"/> Gold Plated	\$CFP

Axle Clamp

<input type="checkbox"/> PC ()	\$50
<input type="checkbox"/> Polished	\$75
<input type="checkbox"/> Gold Plated	\$CFP

Axle Plates

<input type="checkbox"/> PC ()	\$65
<input type="checkbox"/> Polished	\$85
<input type="checkbox"/> Gold Plated	\$CFP

Camber Plates

<input type="checkbox"/> PC ()	\$50
<input type="checkbox"/> Polished	\$75
<input type="checkbox"/> Gold Plated	\$CFP

Axle Bases

<input type="checkbox"/> PC ()	\$50
<input type="checkbox"/> Polished	\$75
<input type="checkbox"/> Gold Plated	\$CFP

Suspension Main Frame

<input type="checkbox"/> PC ()	\$150
<input type="checkbox"/> Polished	\$400
<input type="checkbox"/> Gold Plated	\$CFP

Upper A-Arms

<input type="checkbox"/> PC ()	\$100
<input type="checkbox"/> Polished	\$300
<input type="checkbox"/> Gold Plated	\$CFP

Lower A-Arms

<input type="checkbox"/> PC ()	\$100
<input type="checkbox"/> Polished	\$280
<input type="checkbox"/> Gold Plated	\$CFP

Suspension Mounts

<input type="checkbox"/> PC ()	N/A
<input type="checkbox"/> Polished	\$90
<input type="checkbox"/> Gold Plated	\$CFP

Camber Plate

<input type="checkbox"/> PC ()	\$50
<input type="checkbox"/> Polished	\$75
<input type="checkbox"/> Gold Plated	\$CFP

Axle Plate

<input type="checkbox"/> PC ()	\$60
<input type="checkbox"/> Polished	\$180
<input type="checkbox"/> Gold Plated	\$CFP

Total Section F \$

1. SEAT WIDTH

Measure from outside of seat tube to the outside of the opposite seat tube.

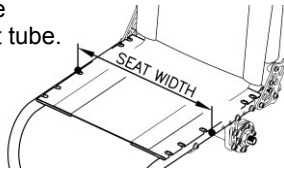

2. SEAT DEPTH

Measure from at the front bottom of backrest tube to the front edge of seat sling.

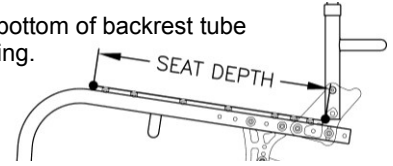

3. FOOTREST WIDTH

Measure from inside of front frame tube to inside of opposite front frame tube.

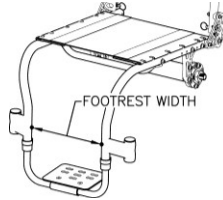

4. FRAME ANGLE

Measure angle frame front to floor.

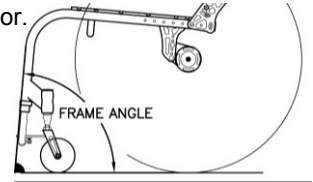

5. BACKREST HEIGHT

Measure from top of back post to seat sling at front bottom of backrest tube.

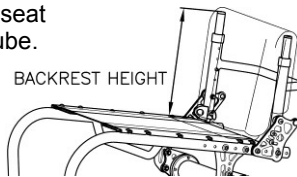

6. BACKREST ANGLE

Measure angle from front of back post to floor.

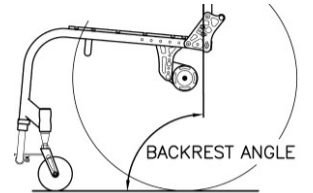

7. FRONT SEAT HEIGHT

Measure from floor to top of seat sling at front edge.

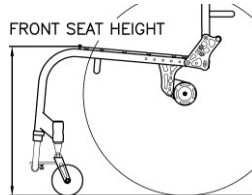

8. REAR SEAT HEIGHT

Measure from floor to top of seat sling at front bottom of backrest tube.

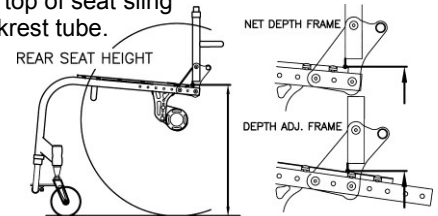

9. CENTER OF GRAVITY

Measure from center of back tube at the folding pivot to the center of the rear axle.

(If welding backrest is selected, Measure from center of back tube at the seat tube to the center of the rear axle.)

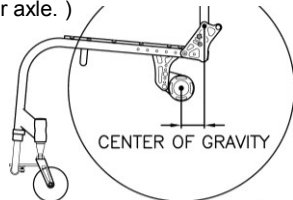

10. CAMBER ANGLE

Measure angle from wheel to vertical at floor.

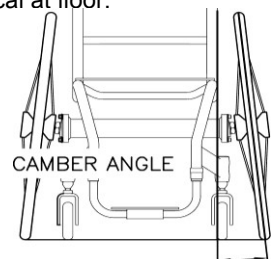

11. FRONT OF SEAT SLING TO FOOTREST

ADULT CHAIR

Measure from top of seat sling at front edge to top of foot plate at front edge.

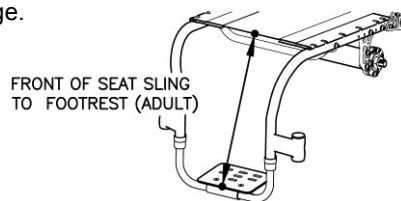

PEDIATRIC CHAIR

Measure vertical from top of seat sling at front edge to top of foot plate.



12. INSIDE WHEEL CLEARANCE

Measure from outside of seat back tube to inside of rear tire.

(If side guards are selected, measure from outside of side guards to inside of rear tire.)

